

INDENOR — XD 4.88

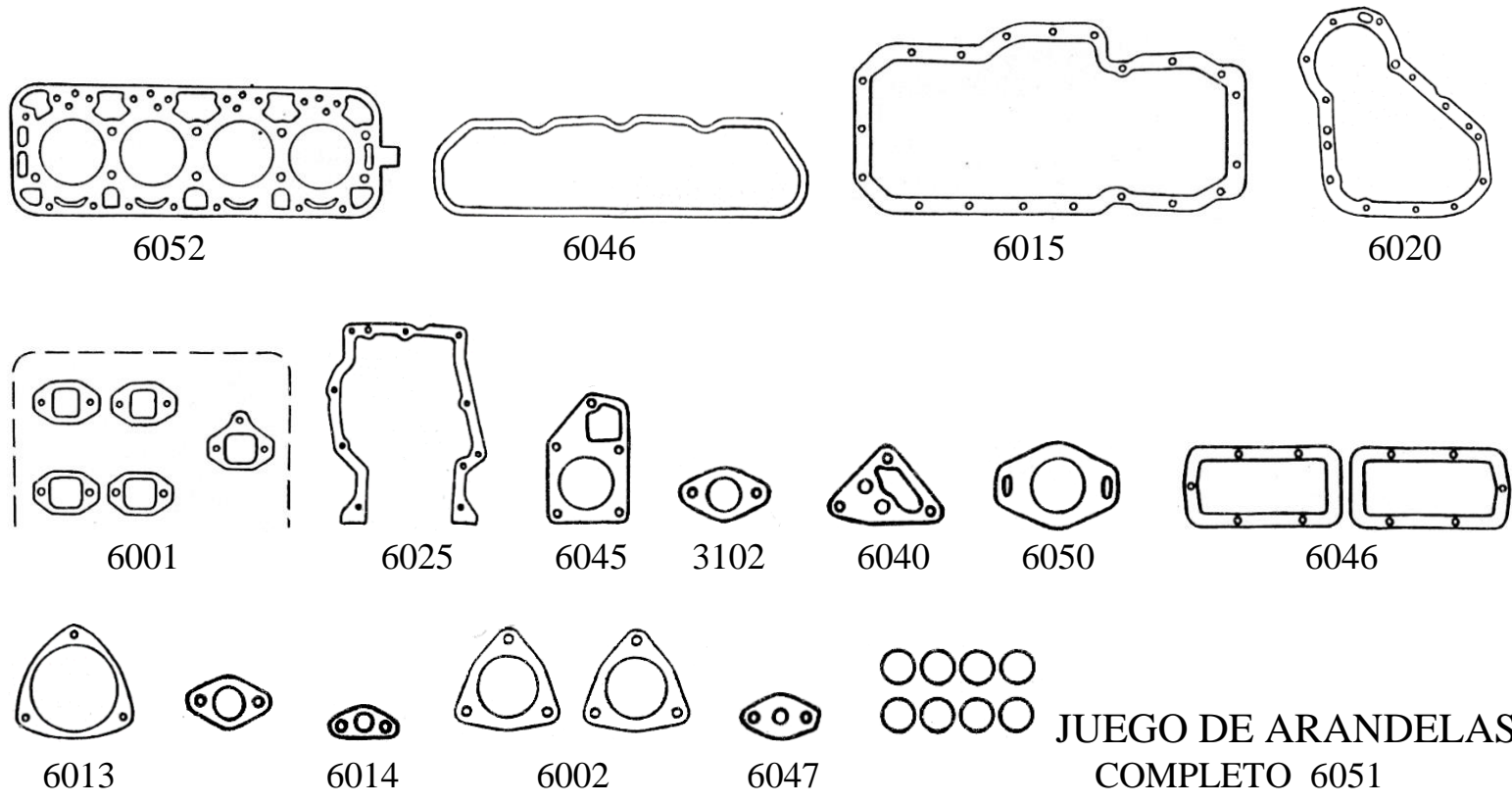

INDENOR XD2 / XD3

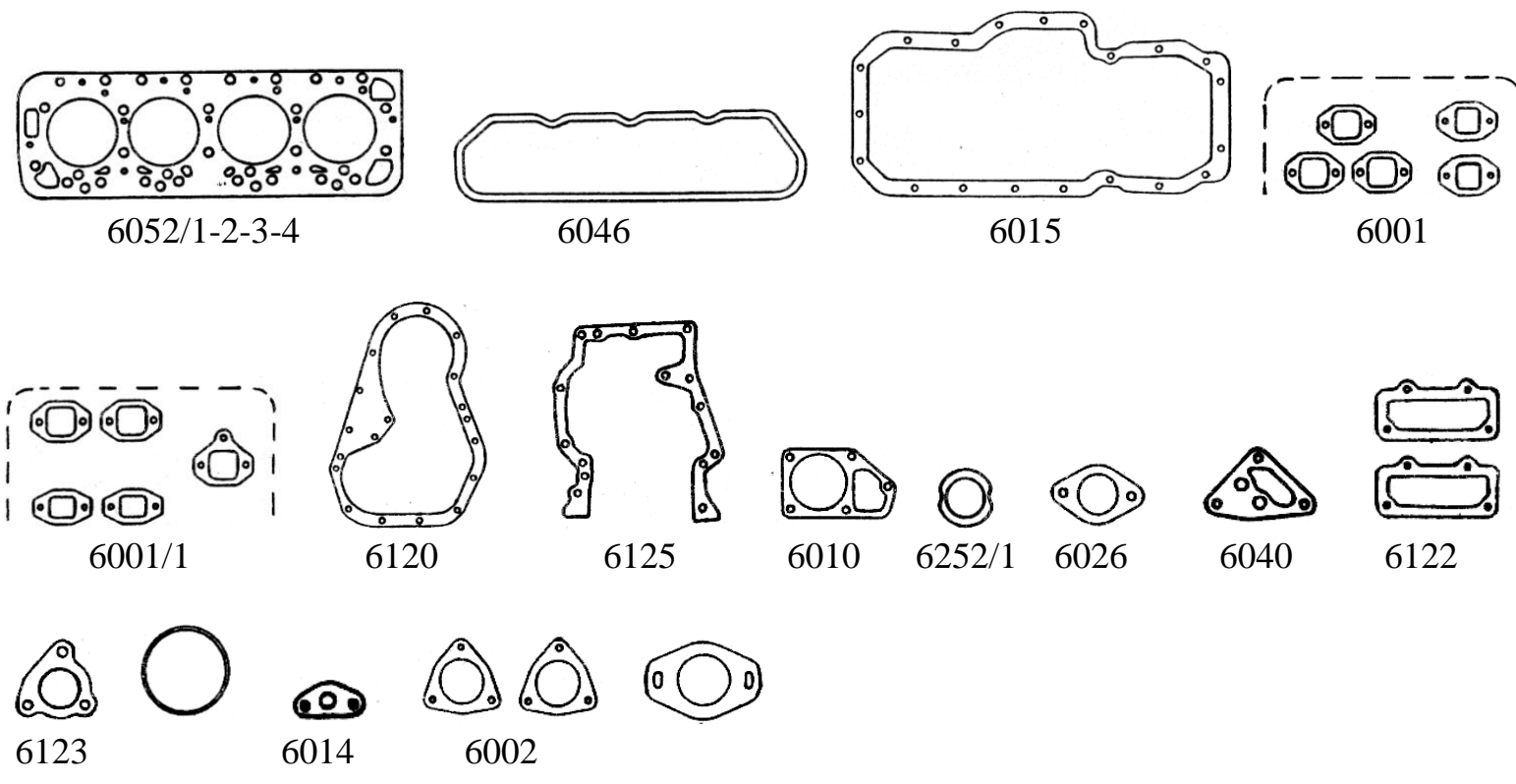

PEUGEOT 504 – MOTOR 1600 CC 1969/1980

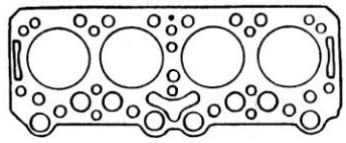

6272

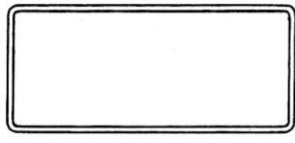

6270

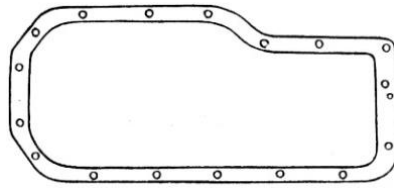

6230

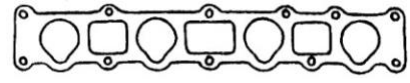

6198

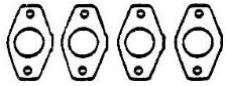

6254



6252



6253

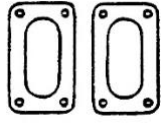

022



6255

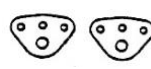

6215



061

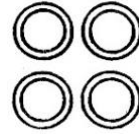

6199



6271



6242

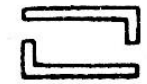

6202



6265



6216



6200



6250

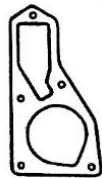

6200

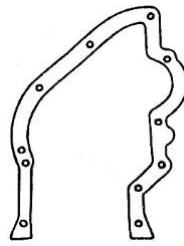

6250

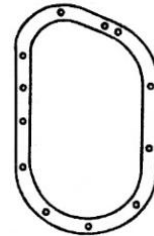

6245

PEUGEOT 504 – MOTOR 1800 CC

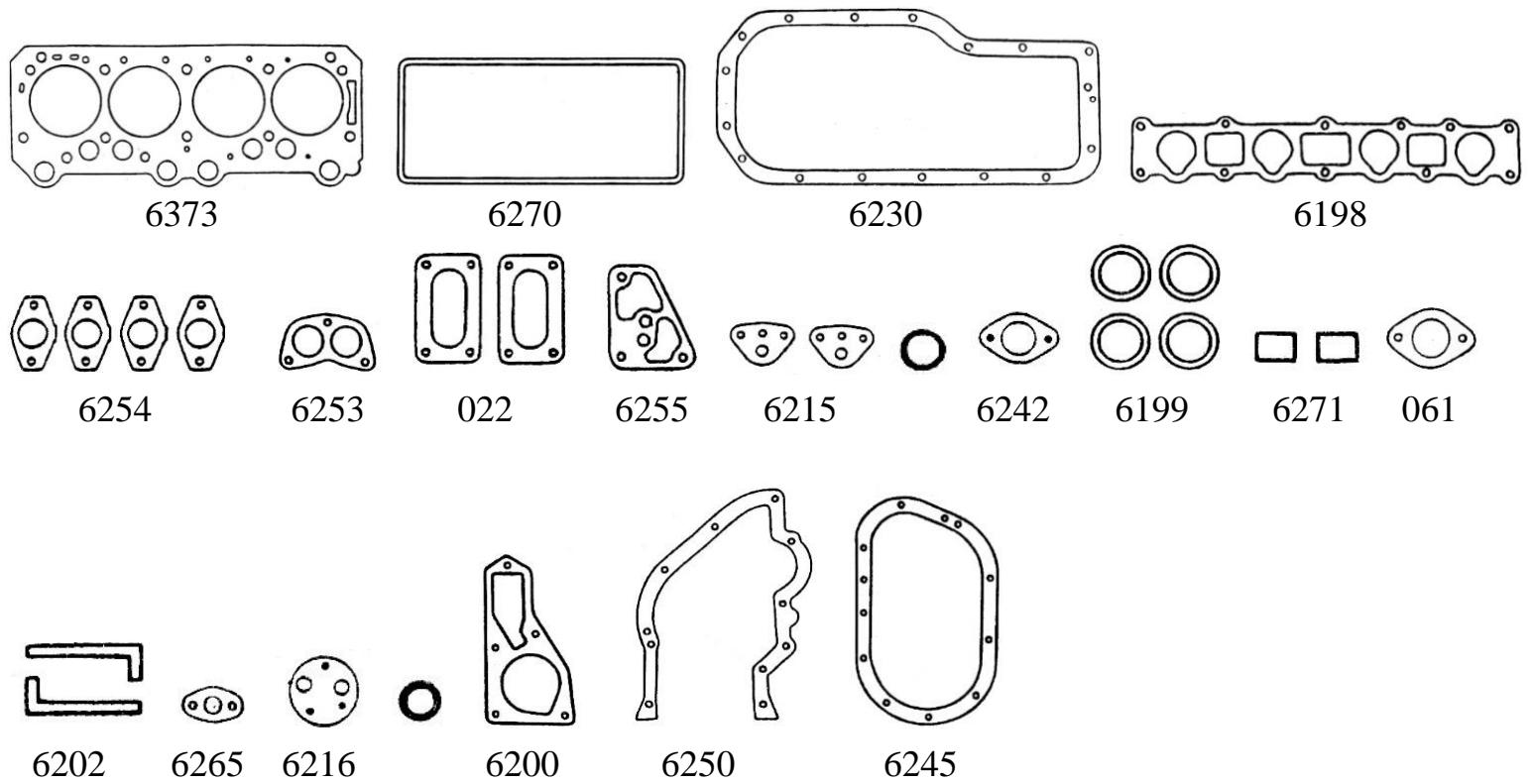

PEUGEOT 504 – MOTOR 2000 CC

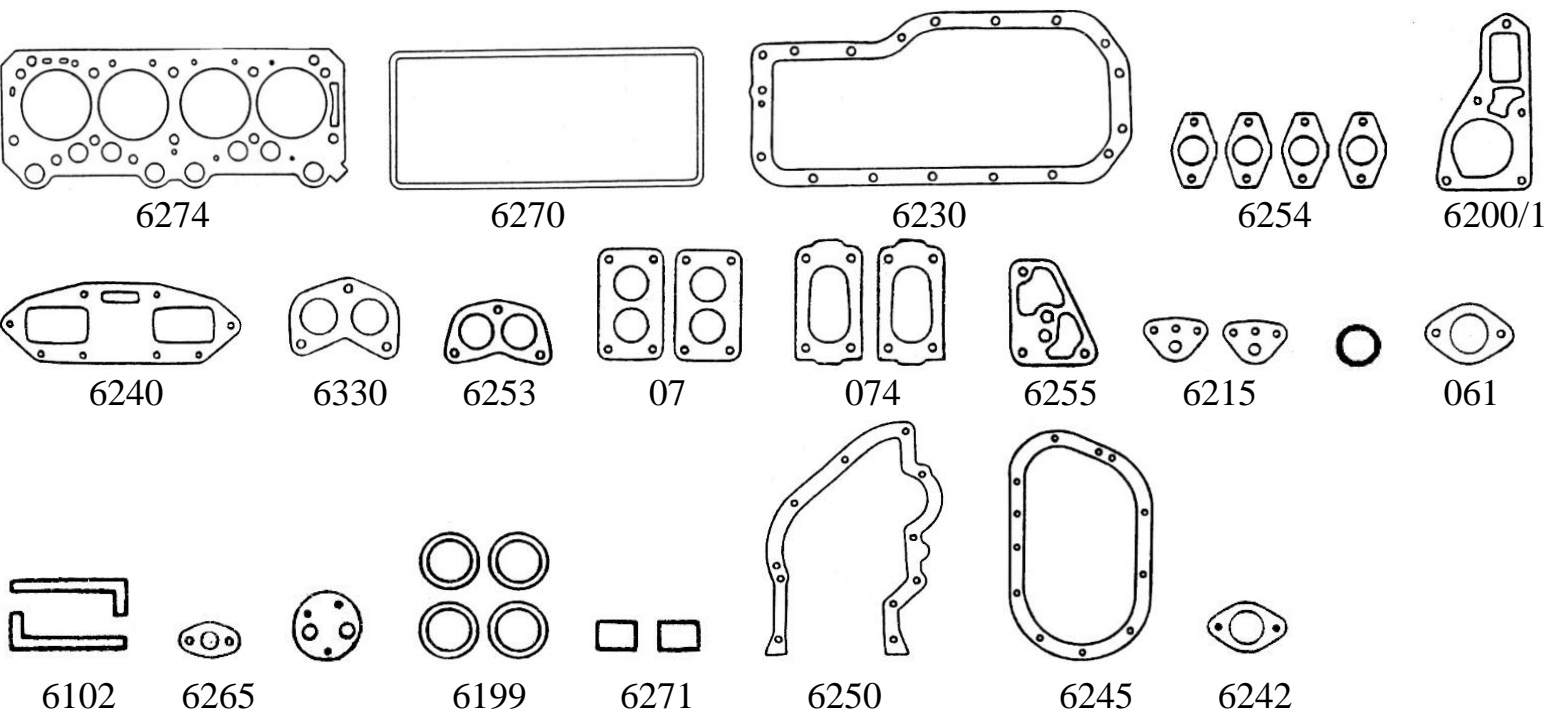

PEUGEOT 505 – GAMMA - INYECCION

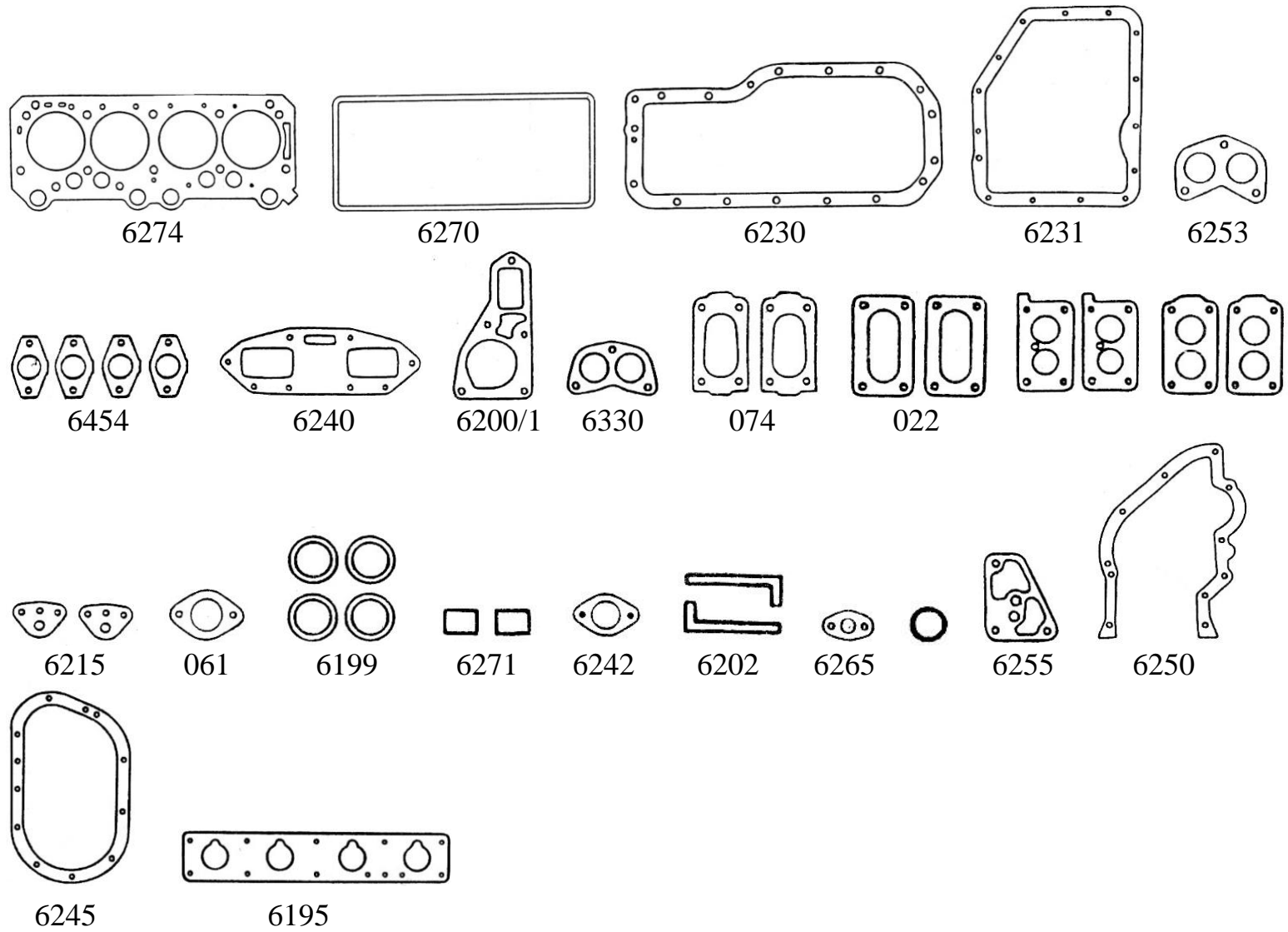

PEUGEOT 505 SRI – MOTOR 2200 C.C.

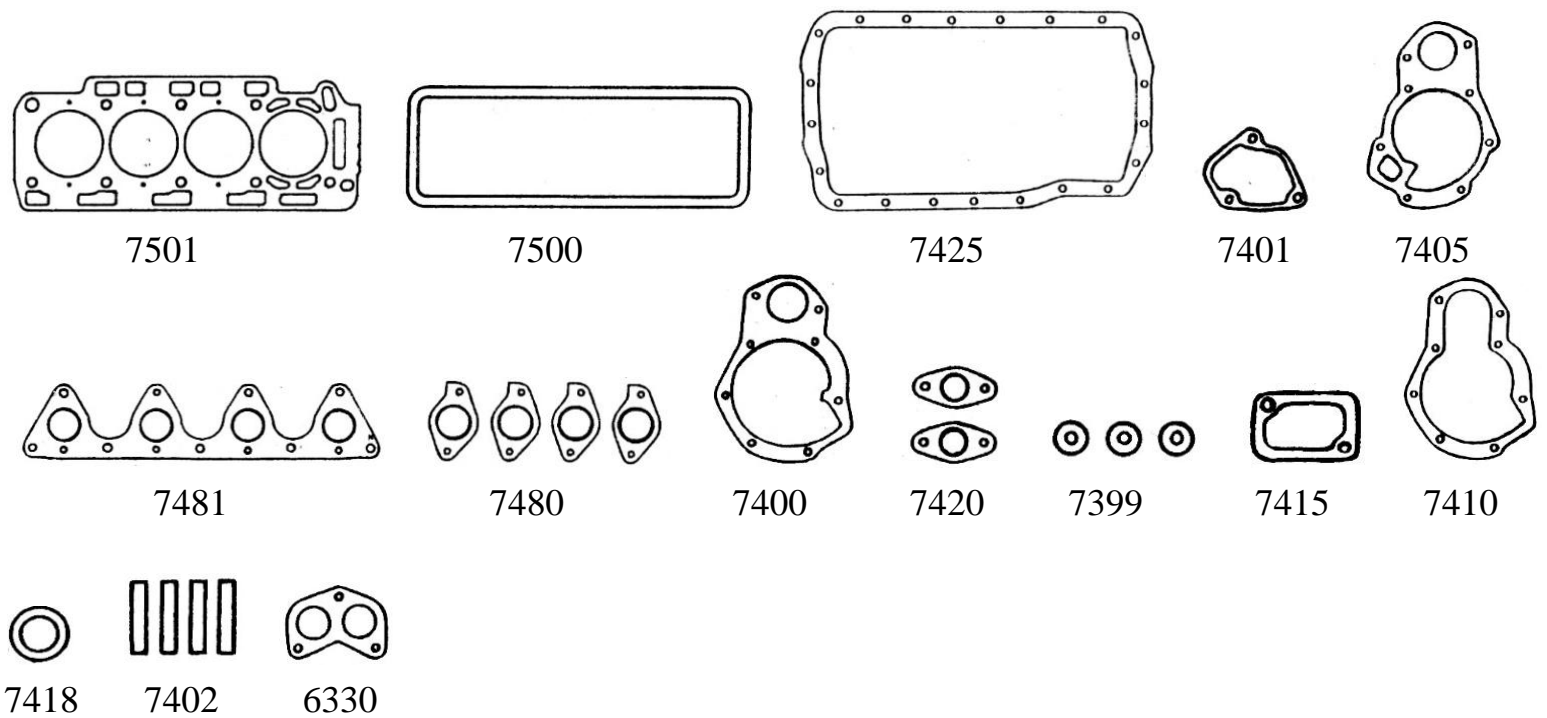

PEUGEOT — 106 — 205 — 306 1991/... 205 RALLYE 1988/93 —
 106 RALLYE 1991/93 MOTOR TU1/TU1M — TU2.4 — TU3 — 306 — 405 — 205
 TD — LADA 2121 — ALEKO — 306 — 406 — 806 — BOXER — EXPERT —
 SUZUKI — VITARA — CITROEN XANTIA TD 1993/...

CITROEN — BX11 — C15 — ZX 1988/... AX SPORT 1987/91 — AX
 GTI 1992/...

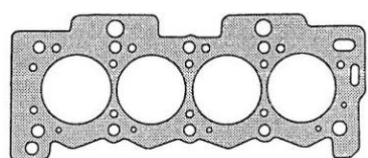

6375

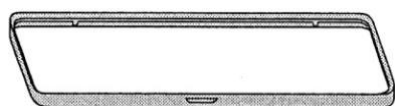

6356

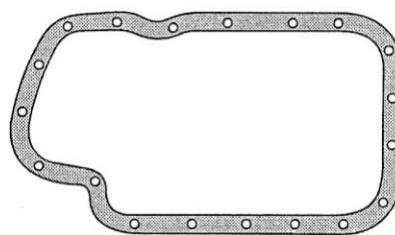

6380

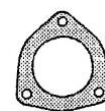

6382

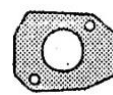

6384

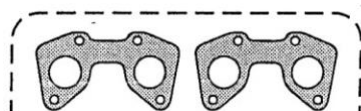
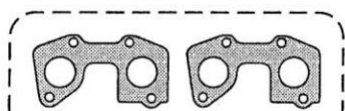

6381

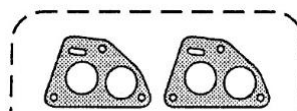

6378



061



6379



6383



6306



1455

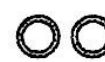

5036

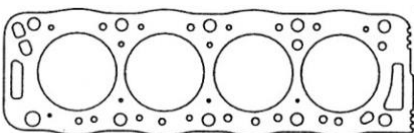

6361

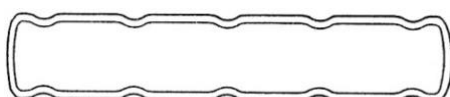

6385

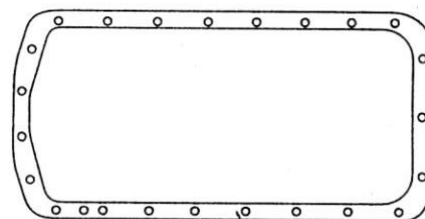

6335



6305

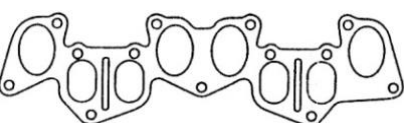

6325



5072



6333

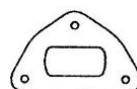

6345

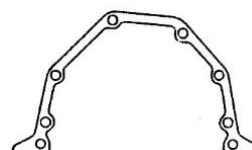

6338



6331



062



6332



6340



6360



6359



6321

PEUGEOT — 306/405/406/806 TD EXPERT TD — BOXER TD 1992/...
CITROEN — XANTIA TD — ZX TD 1993/... - **SUZUKI** — VITARA

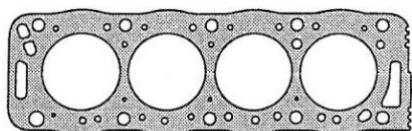

N/D



6385

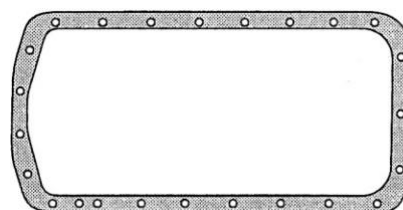

6335

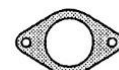

5072

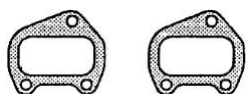

6336



6325

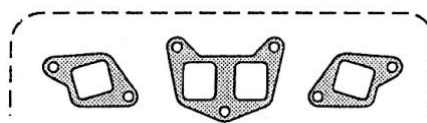

6334



6305



6333

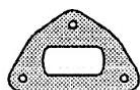

6345

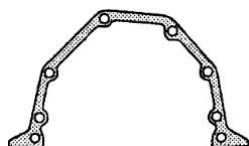

6338

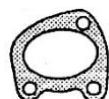

6331



062

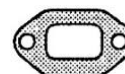

6332



6340



6202



6360



6359



6321

PEUGEOT — 205 TD 1990/1996 — 405 TD 1990/1992 — 309 TD

1988/94 — **CITROEN** — BX 17 TD 1988/92 — **ROVER** — 218 TD — 418 TD

1991/96 — TOURER TD 1996/... - MOTOR XUD7T — TE 1769cc.

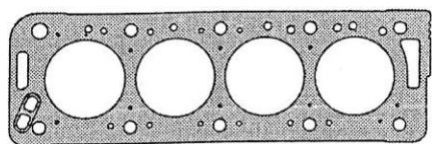

N/D

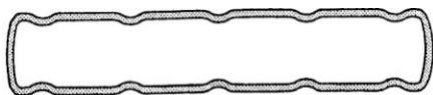

6385

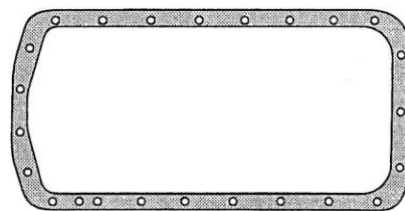

6335

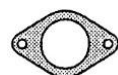

5072

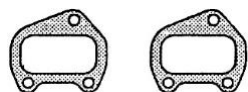

6336

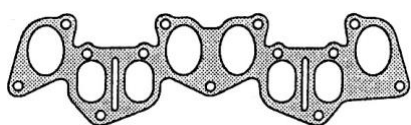

6325

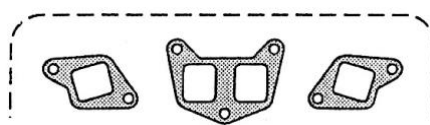

6334



6305



6333

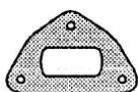

6345

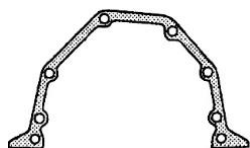

6338

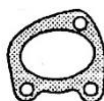

6331



062

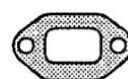

6332



6340



6360



6359



6321

PEUGEOT MOTOR XU7JP – XU7JP/Z – XU7JP – XU7JB

1761cc. – 306 1993/... - 405/406 1992/... - 406 1997/... - CITROEN –

XANTIA 1997/01 – XSARA/...

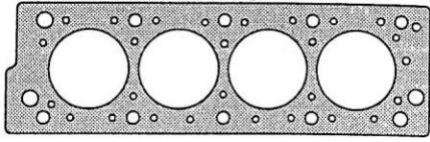

6348

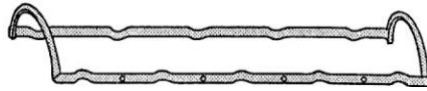

6351

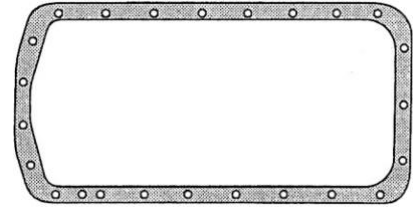

6335

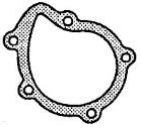

6305

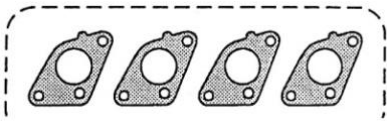

6353

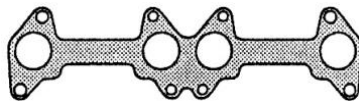

6354

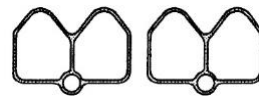

6303

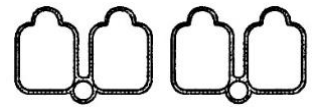

6391



6577



6304



6340



6202

PEUGEOT XU92C 1905cc. – 306 – 405 – 309GT –

305GTX – CITROEN – BX19 1984/93

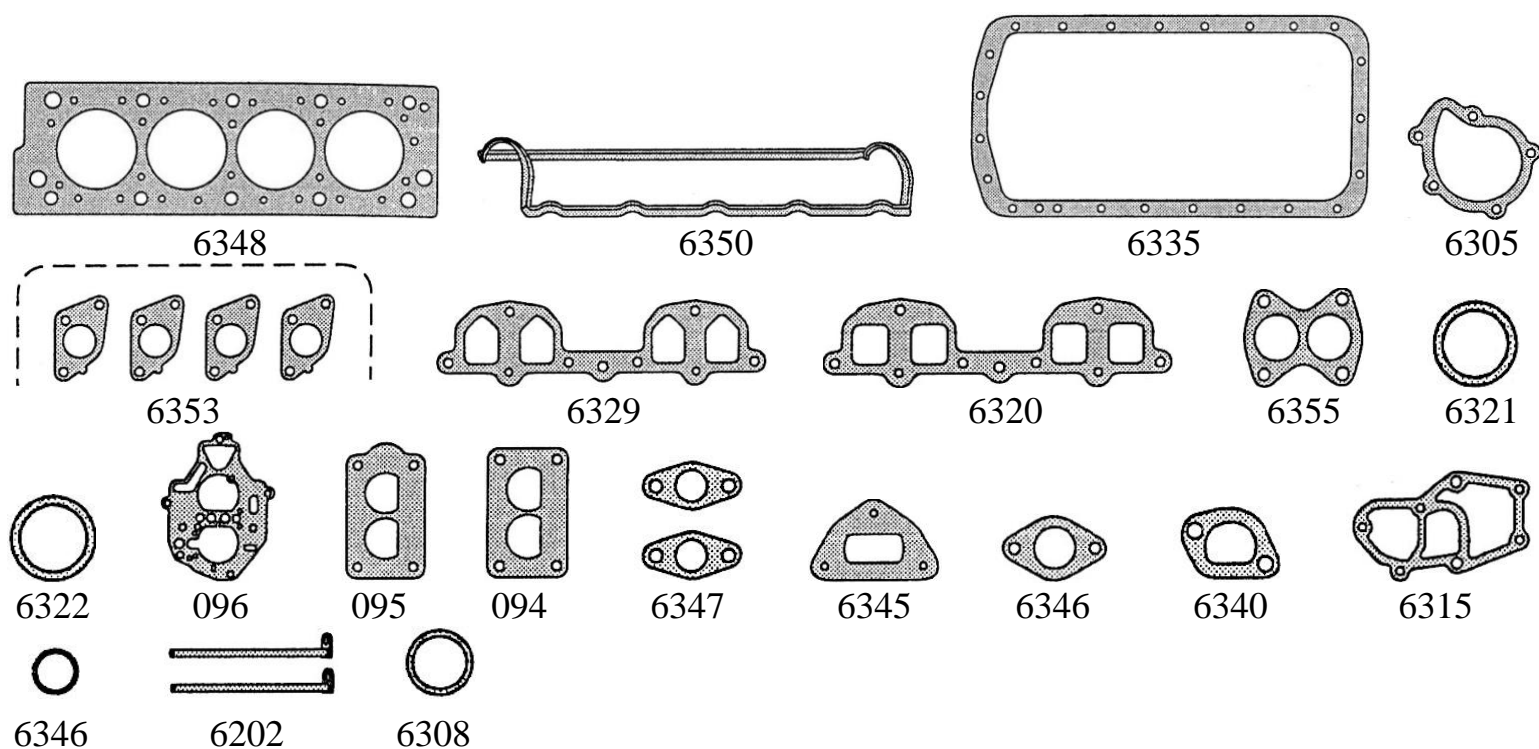

PEUGEOT MOTOR – XUD9 1905cc – 305 – 306 – 205 – 309 –

405 – EXPRESS – HYUNDAI – LANTRA 1998/... - LANDA – NIVA

2121 – ALEKO 1990/... - ROVER -218 – 418 67HP 1991/96 –

SUZUKI – VITARA 68HP 1995/96

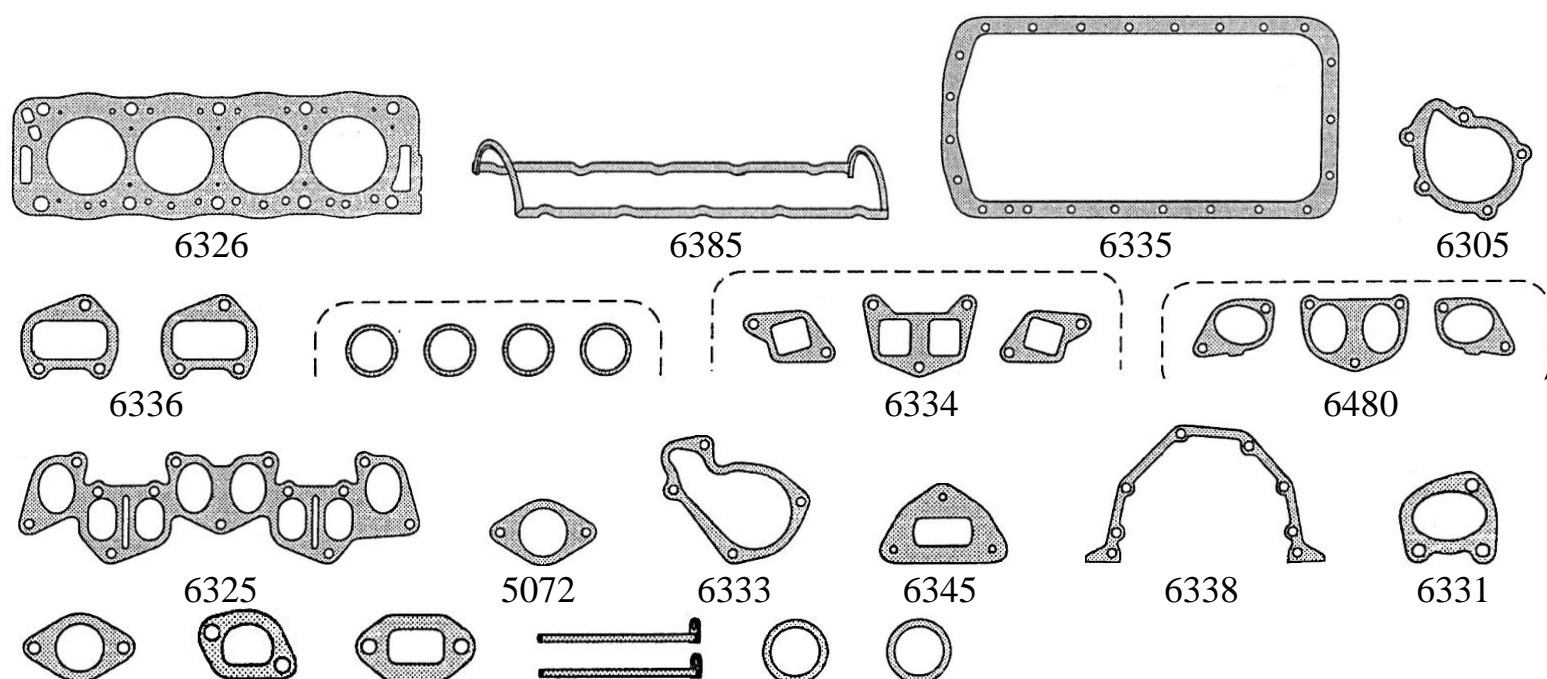

PEUGEOT MOTOR XU10 J2TE 1998cc. – 406 – 605 – 806
TURBO 1996/...

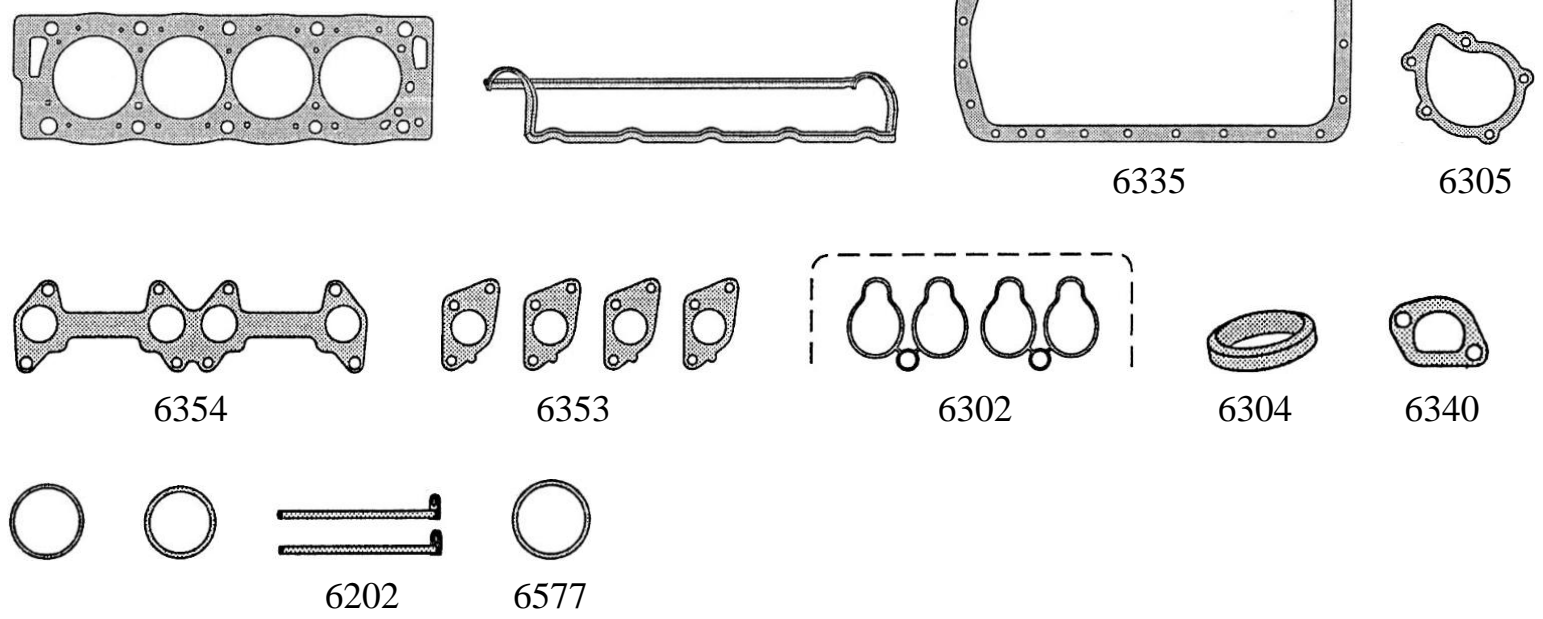

PEUGEOT MOTOR – XU10J2C 1998cc. – 405 1992/... -
306 1993/... - CITROEN – ZX 1992/... - XANTIA 1993/98

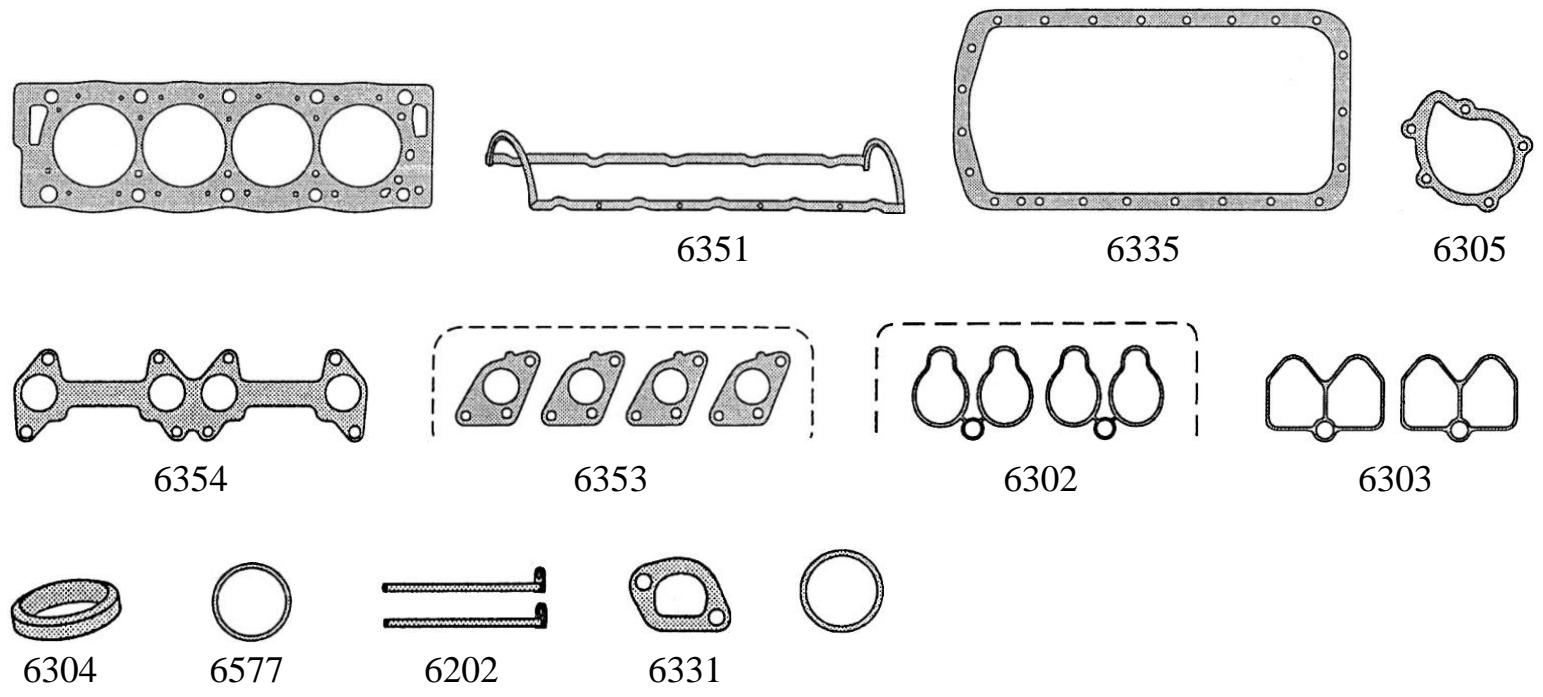

PEUGEOT MOTOR XU7JP4 DOHC 16V 1761cc. – 306

1997/... - 406 1995/96 – 406 1997/... - CITROEN – XSARA 1997/...

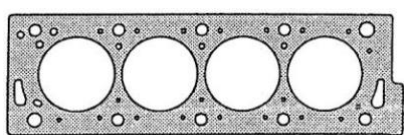

6588

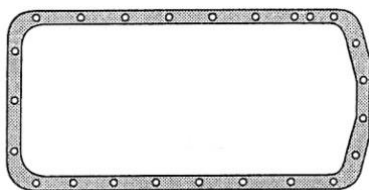

6335

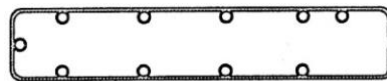

6579



6305

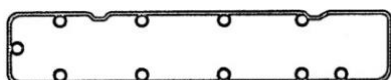

6580

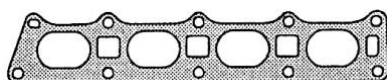

6390

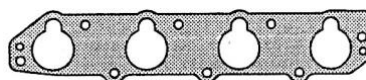

6581

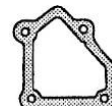

6584



6578



6202



6577



6308



1420



6323

PEUGEOT MOTOR XU7JB 1761cc. – PARTNER 1997/... -

CITROEN – BERLINGO 1997/...

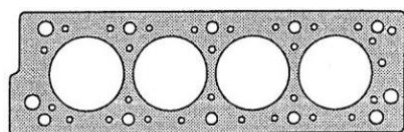

6588



6351

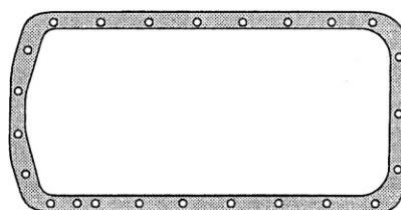

6335

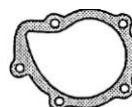

6305



6354

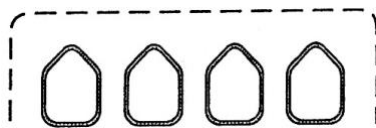

6301



6304



6577

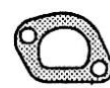

6340



6202



PEUGEOT MOTOR DW8 WJZ 1868cc. – 206 – 306 – 806
EXPORT – PARTNER 1998/... - CITROEN – BERLINGO – XSARA –
JUMPY 1998/...

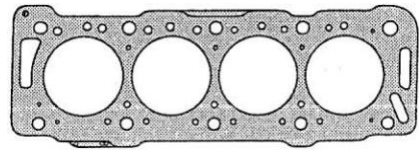

6480

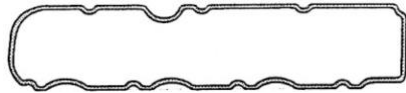

6485

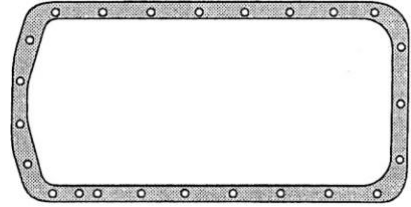

6335



6305

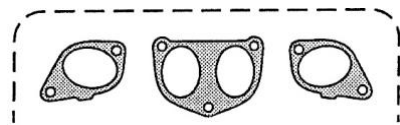

6480

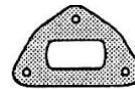
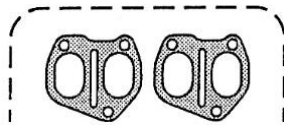

6345



6340



6202



6577

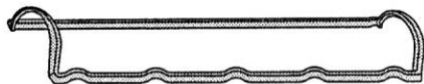

6486

PEUGEOT MOTOR XUD7 161A/A9A 1769cc. – 205

1995/96 – 306 1997/... - PARTNER 1996/... - CITROEN – C15 1994/...

BERLINGO 1996/99 – XSARA 1997/...

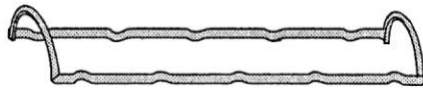
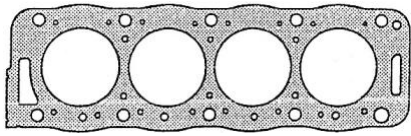

6385

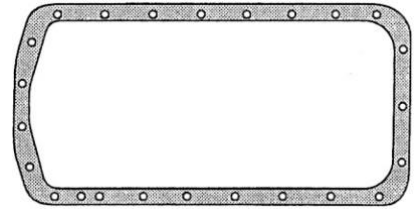

6335



6305

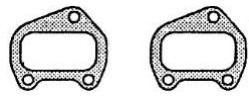

6336

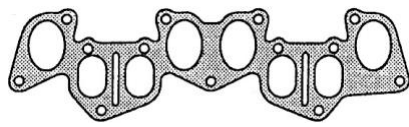

6325

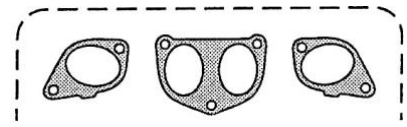
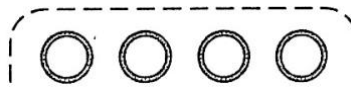

6480

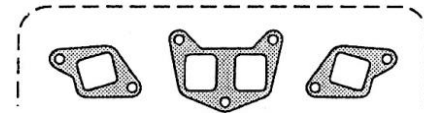

6334

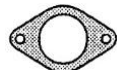

5072

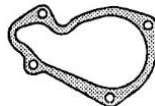

6333

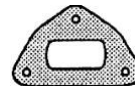

6345

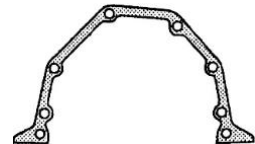

6338

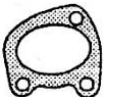

6331



6340

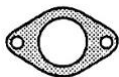

062

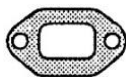

6332



6360



6360

PEUGEOT – MOTOR TU5JP/J2 1587CC. - 106 1994/... -
 306 1993/... - 206 1998/... - **CITROEN** – ZX – SAXO 1996/... -
 XARA 1997/...

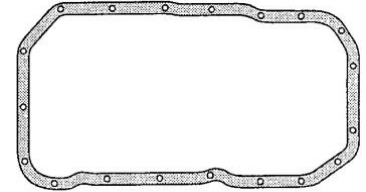
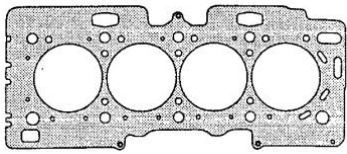

6356

6735

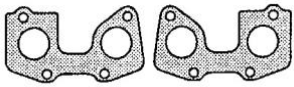

6750



6734



6577

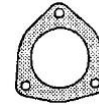

6382



6357



6634

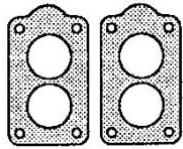

095



1455

PEUGEOT – MOTOR TU3F/F2/FM 1360CC– TU3M/MC
 1360CC – 106 1994/96 – 309 1992/93 – 405 1993/94 – 205 1991/93
CITRONEN – AX14 – BX14 1991/... - ZX 1994/... - AXGT 1993/... -
 C15 1991/...

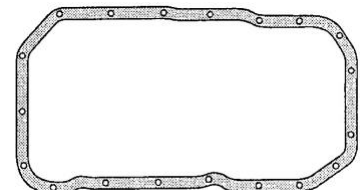
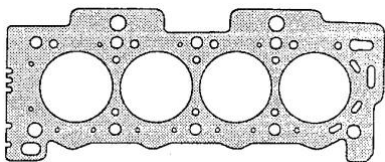

6356

6735

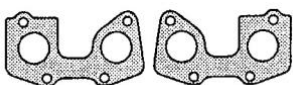

6750

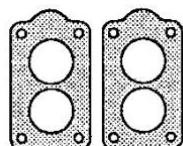

095



1455



6357

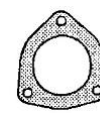

6382



6634



PEUGEOT – MOTOR DW10TD 2.0 – TRACKER – VITARA –
 GRAN VITARA – JGO MOTOR N° 6500/2 – MEDIO MOTOR N° 6500/20

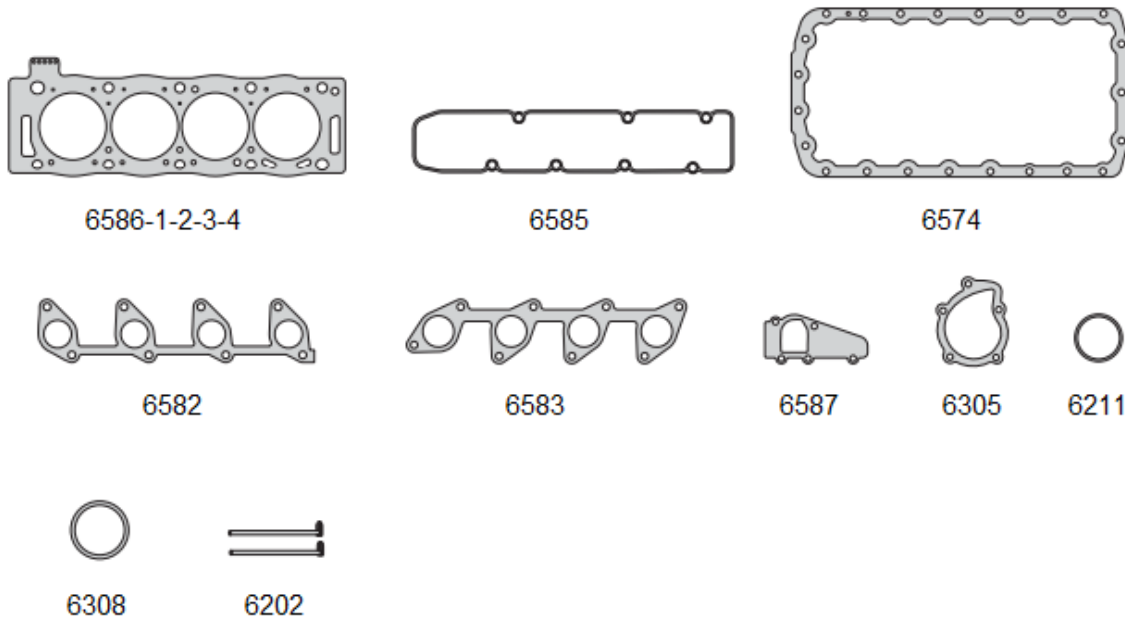

PEUGEOT – MOTOR EW10J4 2.0 – 206 – 307 – 406 – 407 16V
 CITROEN C4 2.0 – XSARA – PICASSO – C5

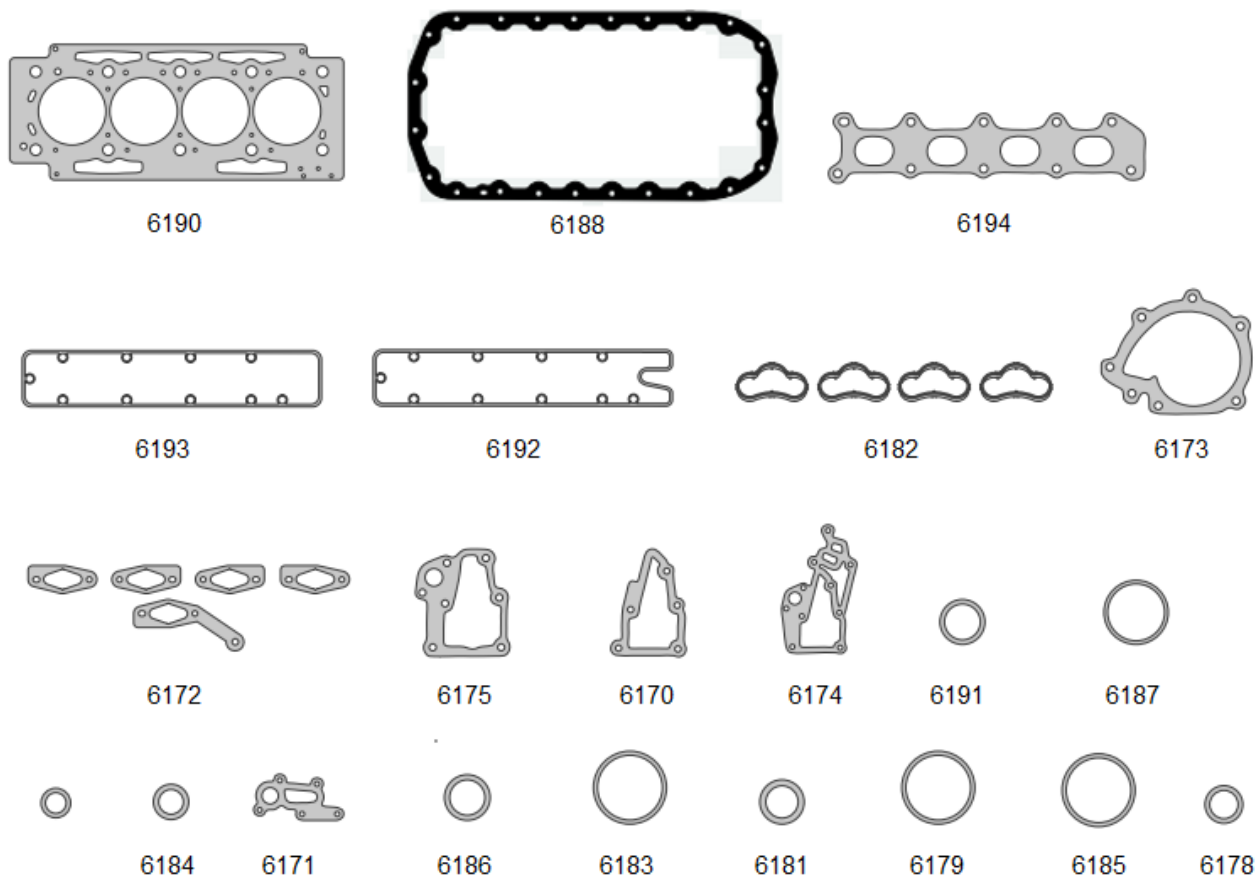

PEUGEOT – MOTOR EW10A 2.0 – 307 – 407 – 807 – 2005/...
CITROEN C4 2.0

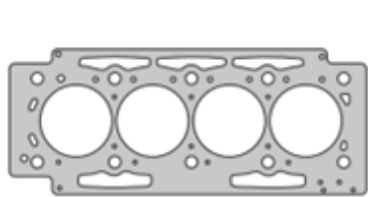

6190



6188



6194



6162



6163



6160



6174



6173



6172



6175



6170



6191



6164



6165



6184



6171



6161



6186



6183



6181



6179



6185



6178

