

CHEVROLET-MOTOR 230-250

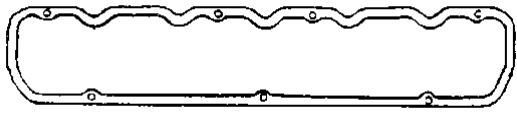

1119



1120

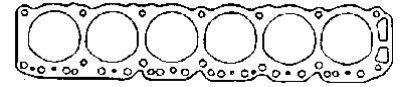

1115

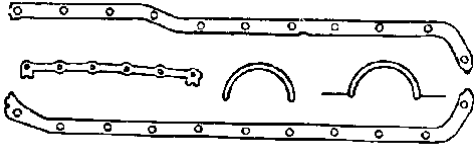

1090



1114



1040



3070



1109

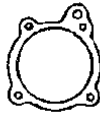

1035



1045

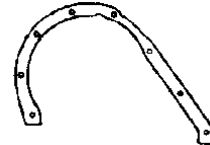

1105



3070



1034



1036



1108



1050

OPEL - K-180

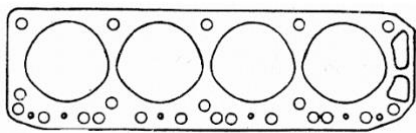

1129

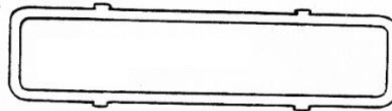

1121

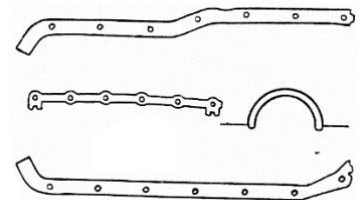

1135

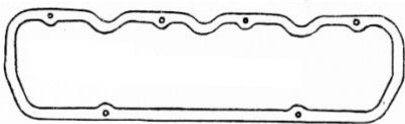

1125



1130

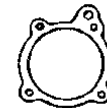

1130

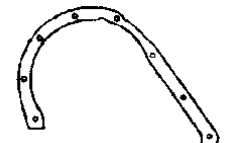

1105



1131

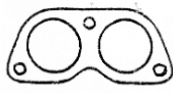

1145



1040



3070



1045



1050



1034

CHEVROLET DIESEL- MOTOR BEDFORD 350

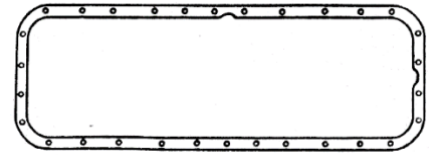
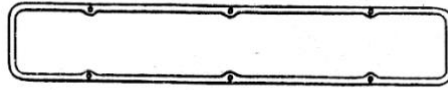
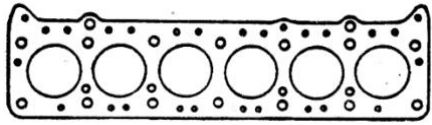

1127

1021

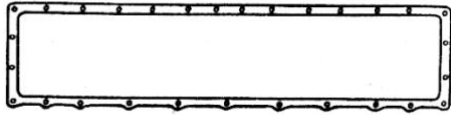

1126

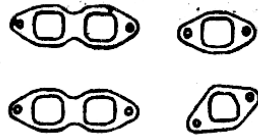

1117

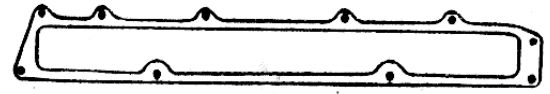

1113

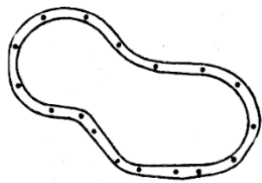

1027

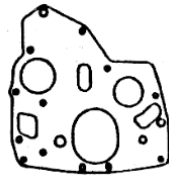

1026

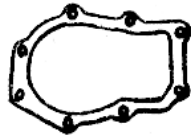

1010



1116



1005



1000



1020



1015



5315

CHEVROLET — CORSA 1.0 EFI B10 NZ 1995/...

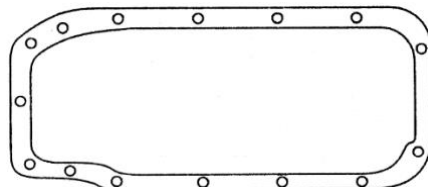
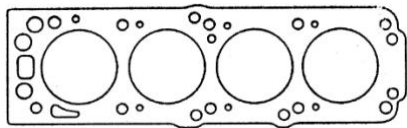

1435

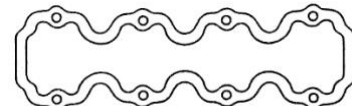

1485



1436

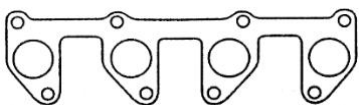

1481

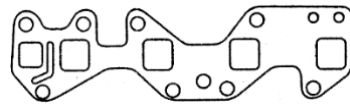

1483

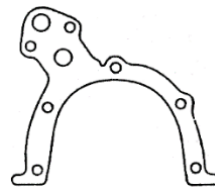

1450



1445



1434

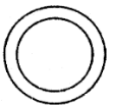

1455



1475



1465

CHEVROLET – CORSA 1,4 EFI – 1,6 MPFI COMBO
KADETT – ASTRA

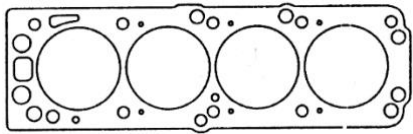

1449

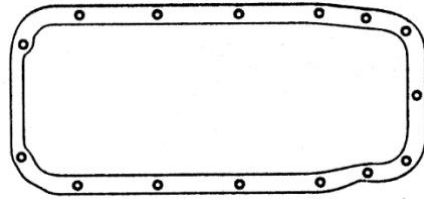

1435

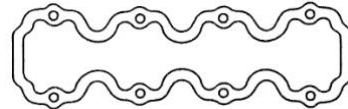

1485

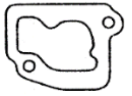

1436

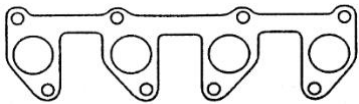

1481

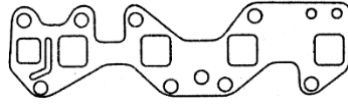

1483



1480

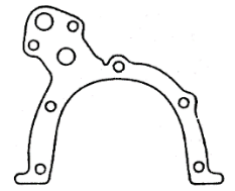

1450

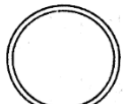

1455



1434

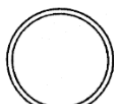

1470



1445



1460



1465

CHEVROLET – CORSA D 1997/... - COMBO D 1998/...-
VECTRA TD 1991/96 – ASTRA TD 1994 /97 . MOTOR 4EE1T – 4EE1
DIESEL 1686 CC

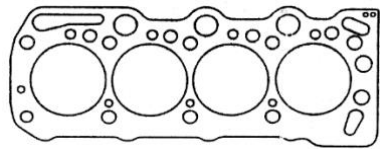

1590

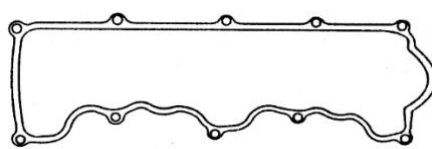

1585

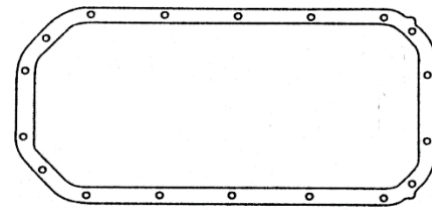

1535

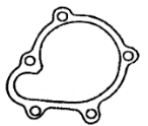

1505



1581

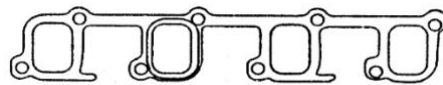

1580

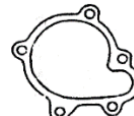

1510



1525



1520



1515



1530



3070



1522

CHEVROLET – CORSA – MERIVA 2003 – FIAT – STYLO
WORKING – ADVENTURE – PALIO 2003

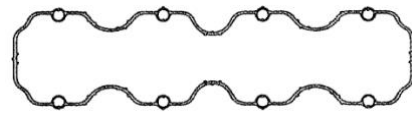
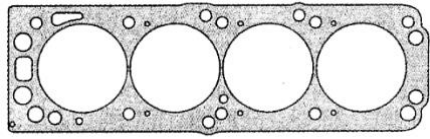

1415

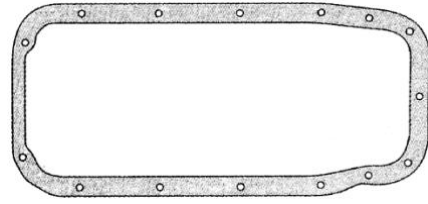

1435

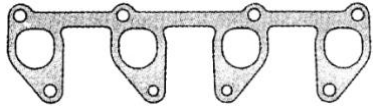
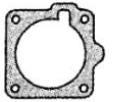

1481

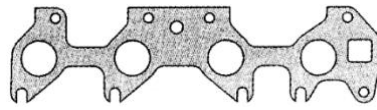

1480

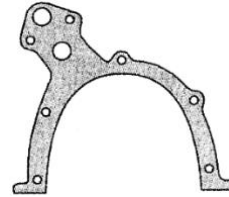

1450

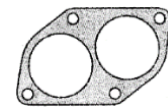

1482



1470



CHEVROLET – GM CORSA – VECTRA – KADETT 1999/...
MOTOR 8V 1,6 CC.

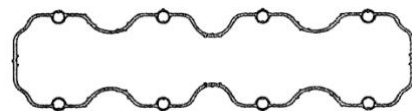
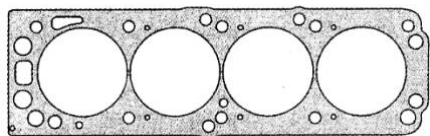

1415

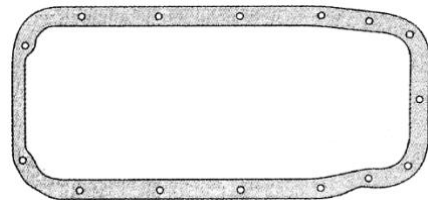

1435

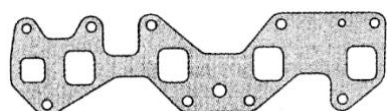
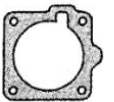

1483

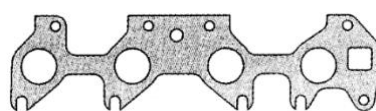

1480

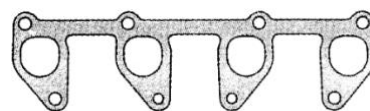

1481

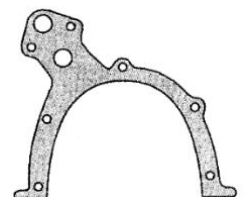

1450



1445



1470



CHEVROLET – CELTA 2000/... – SUZUKI – FUN 2002/... -
MOTOR 1,0 CC.

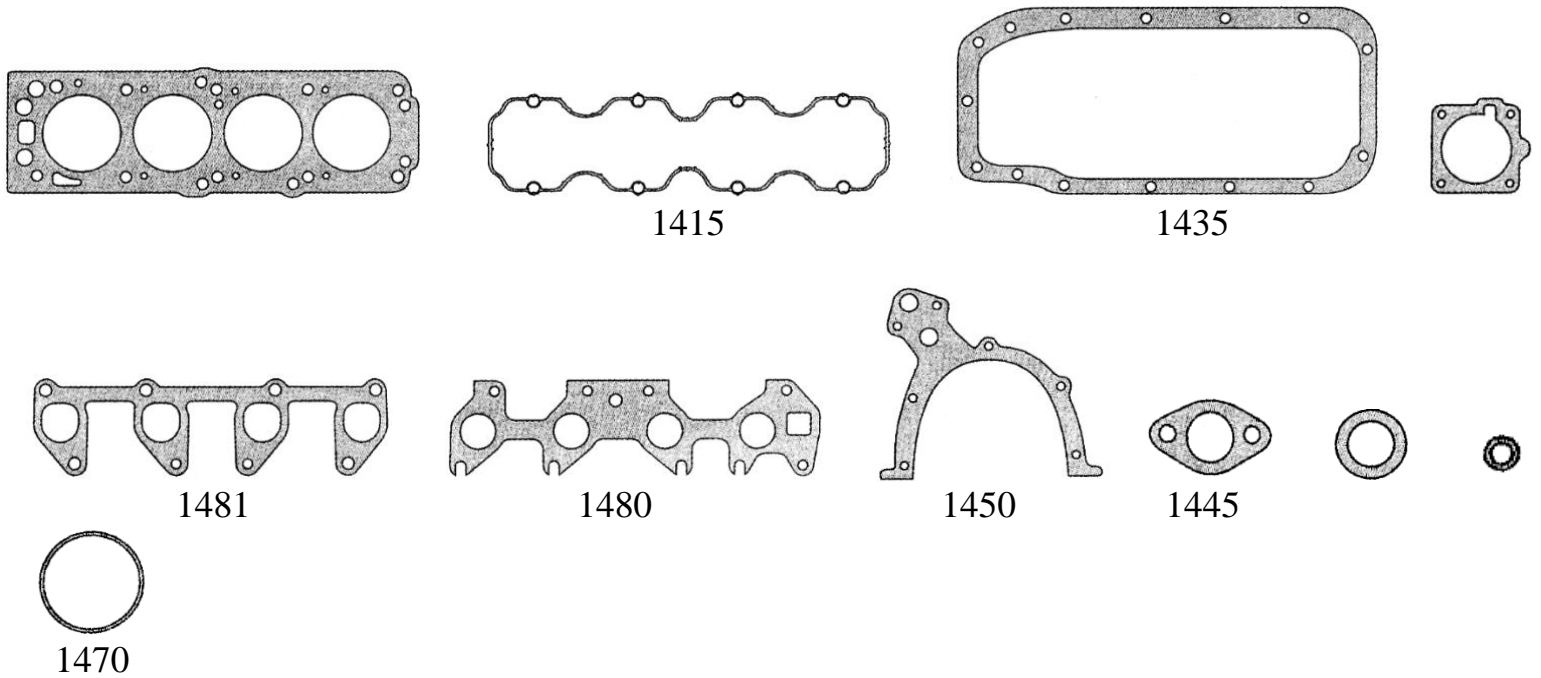

CHEVROLET – ASTRA – VECTRA – ZAFIRA – 2.0-2.2 16V
MOTOR X20XEV – X22XE
1600/3 Jgo Motor S/T.CIL 1600/20 Jgo Medio Motor S/T.CIL

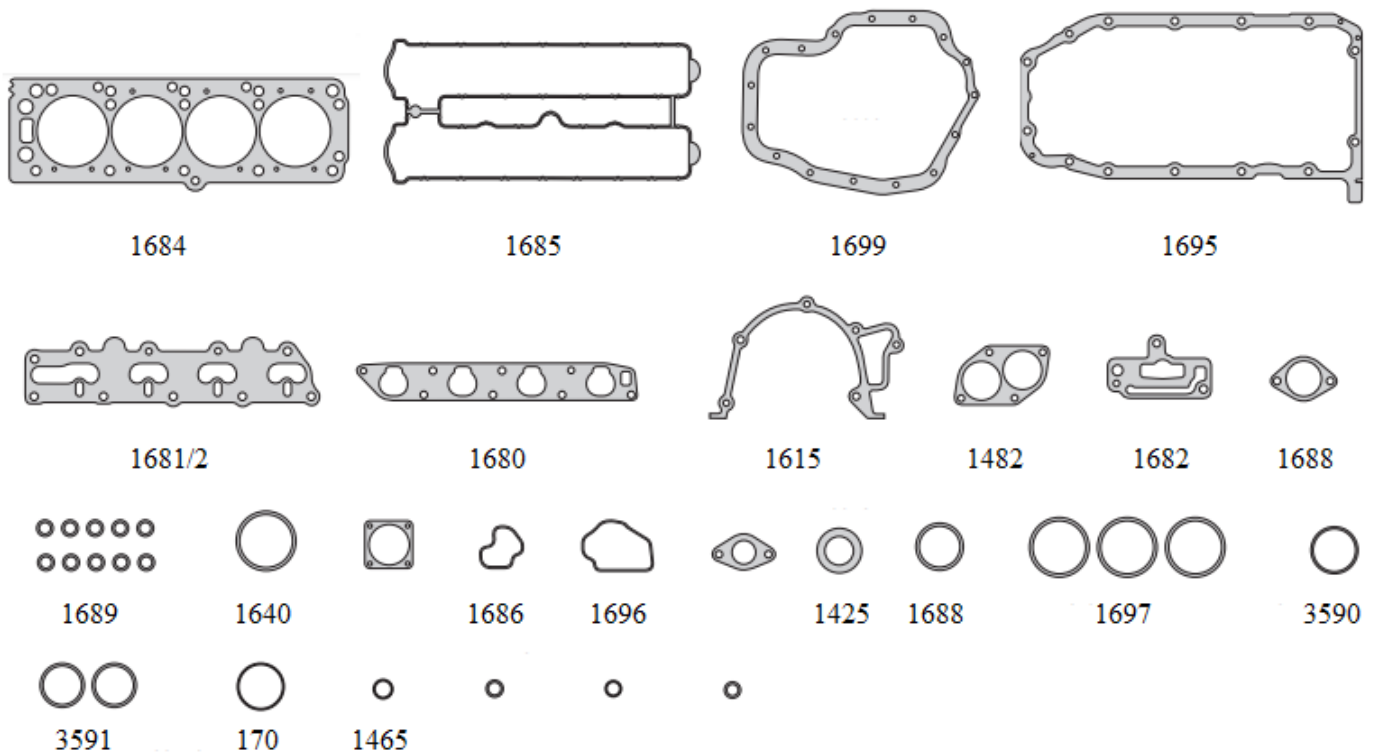

CHEVROLET — ASTRA 2.0-2.2 16V MOTOR X20XEV-X20SED
 1600/2 Jgo Motor S/T.CIL 1600/20 Jgo Medio Motor S/T.CIL

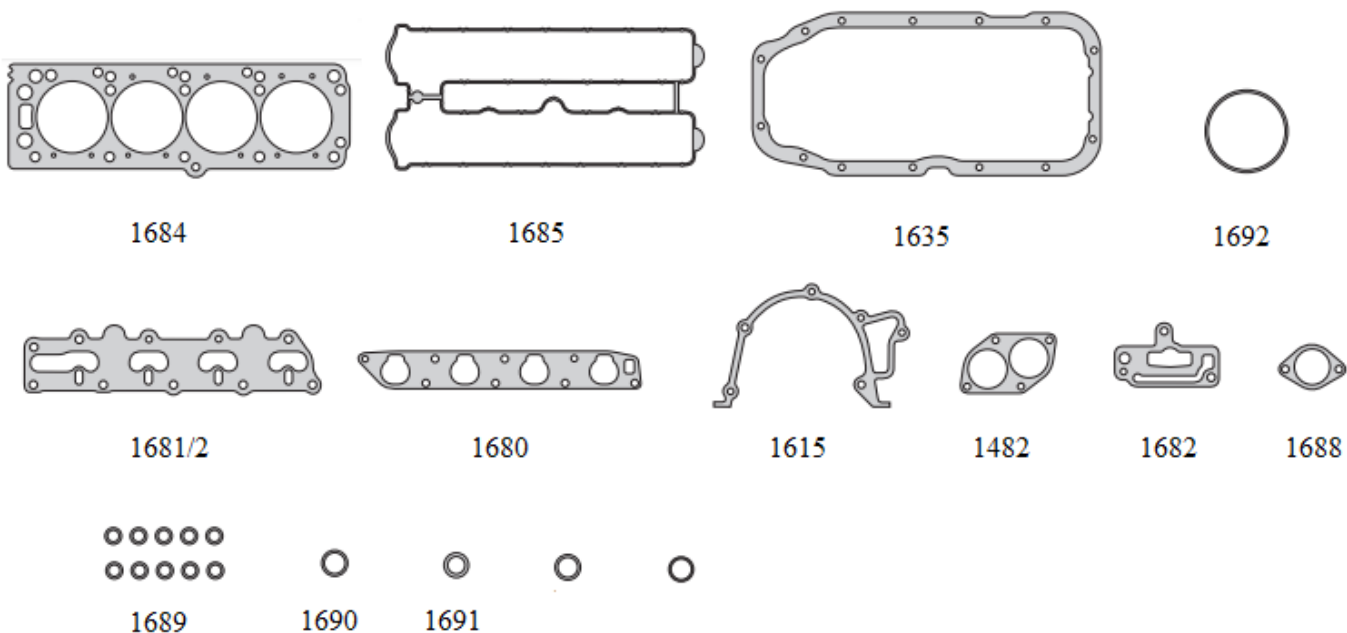

CHEVROLET – MOTOR D5 1399 cc/ D3 1598 cm3
 NUBIRA 2003/05 – AVEO MPI 2004/...
 DAEWOO – KALOS – LANCETTI 2004/... NUBIRA 2003/05

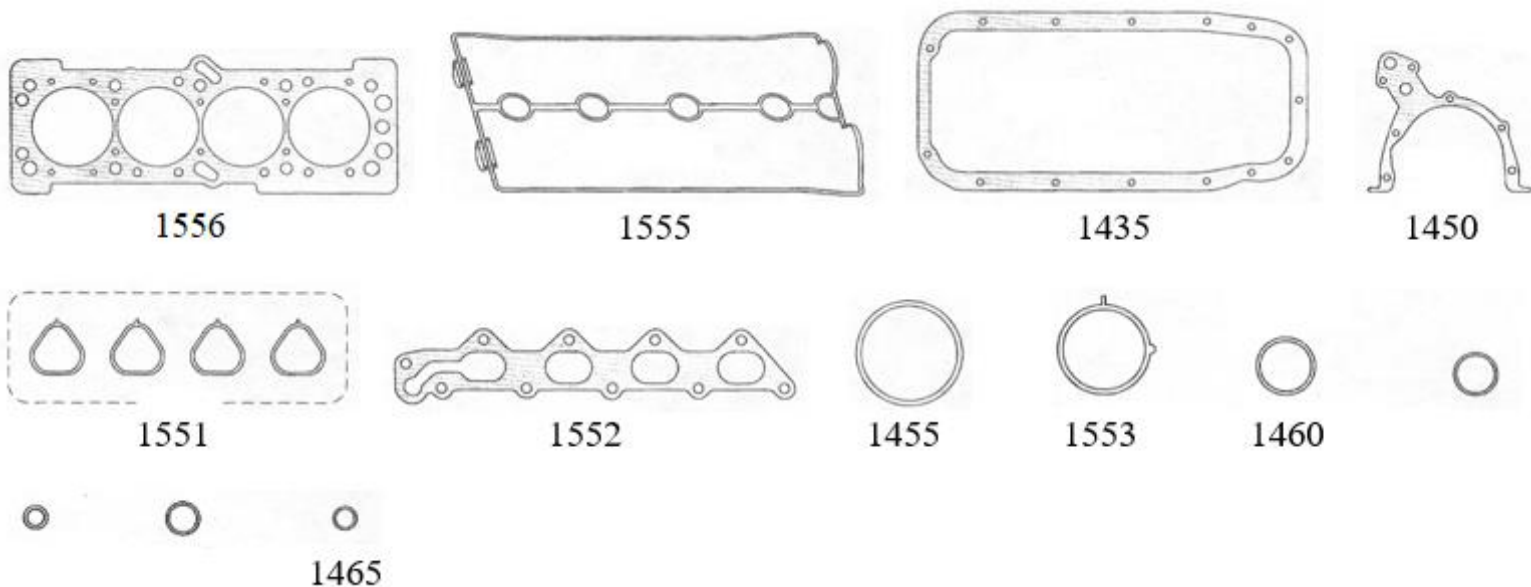

CHEVROLET - CRUZE-TRACKER 1.8-SONIC-ONIX-COBALT 1.6

4 Cil 16V – ECOTEC F18D4 DOHC 2008>>>

Jgo Motor S/T/Cil N°1500/2



1500

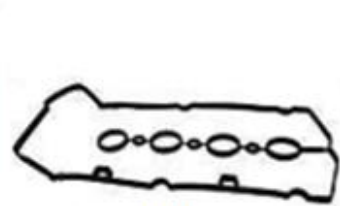

1560



1561



1565



1583



1562



1576



1563



1566



1567



1572



1569



1567



1570



1568



1571



1573



1574



1575



1578



1579



1577