

# FORD FALCON SP – MOTOR 221 `` SPRINT

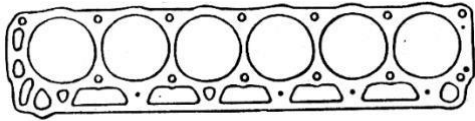

3131

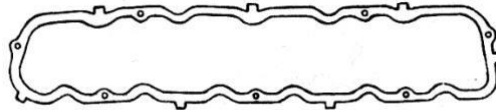

3130

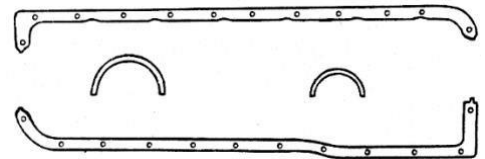

3085



3128

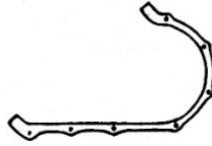

3100



3005



1145



3010

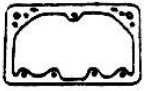

065

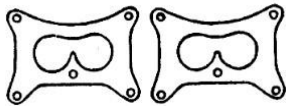

067

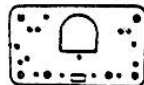

066



064



3000



1050



3080



3035

# FORD MAX ECONO – FALCON – PICK – UP

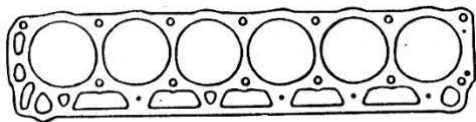

3131

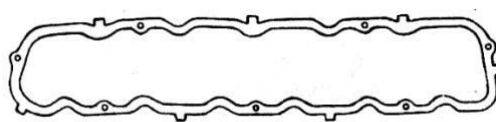

3130



3085



3129

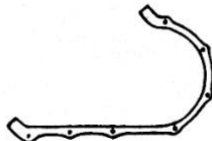

3100



3005



3103



3010

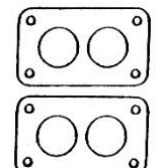

07

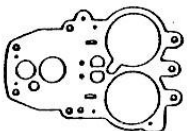

04



3000



1050



3035

# FORD SIERRA – MOTOR 1,6

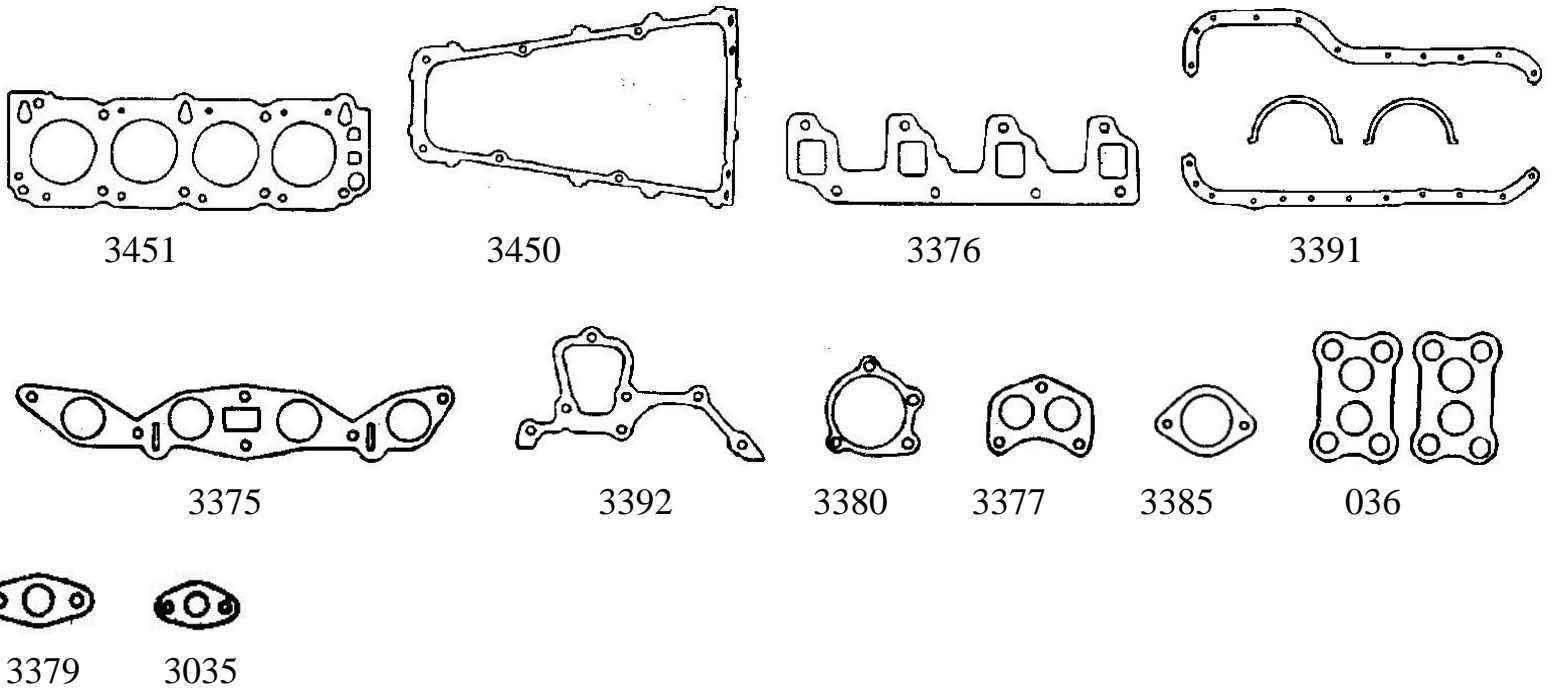

# FORD FALCON – MOTOR 188 – 221'' 4 Y 7 BAS

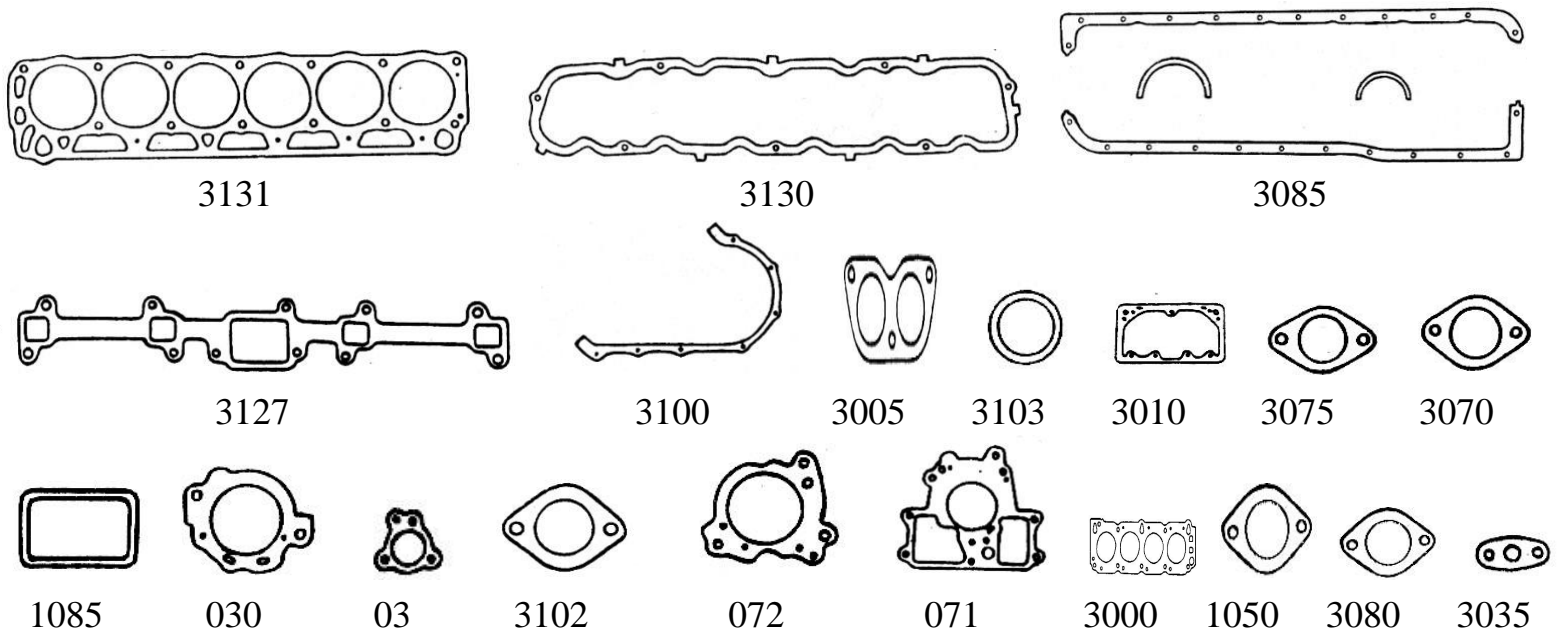

# FORD TAUNUS – MOTOR 2300 CC

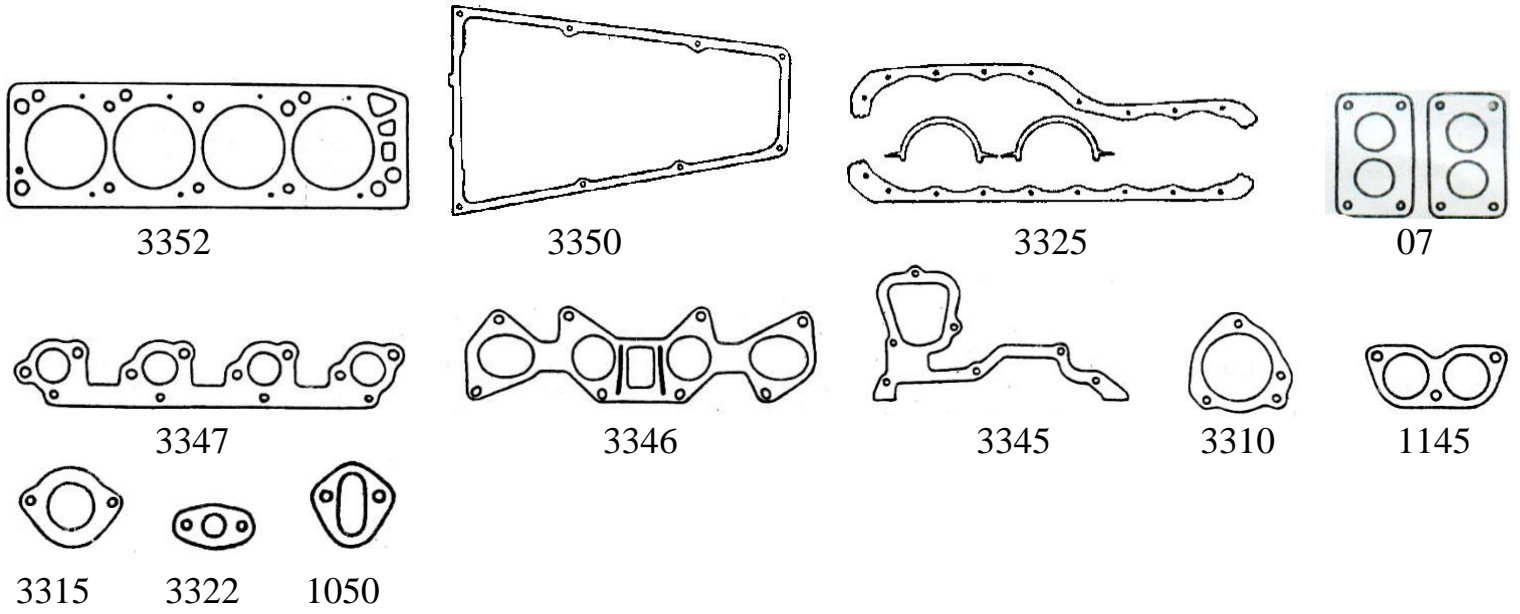

# FORD TAUNUS – MOTOR 2000 CC

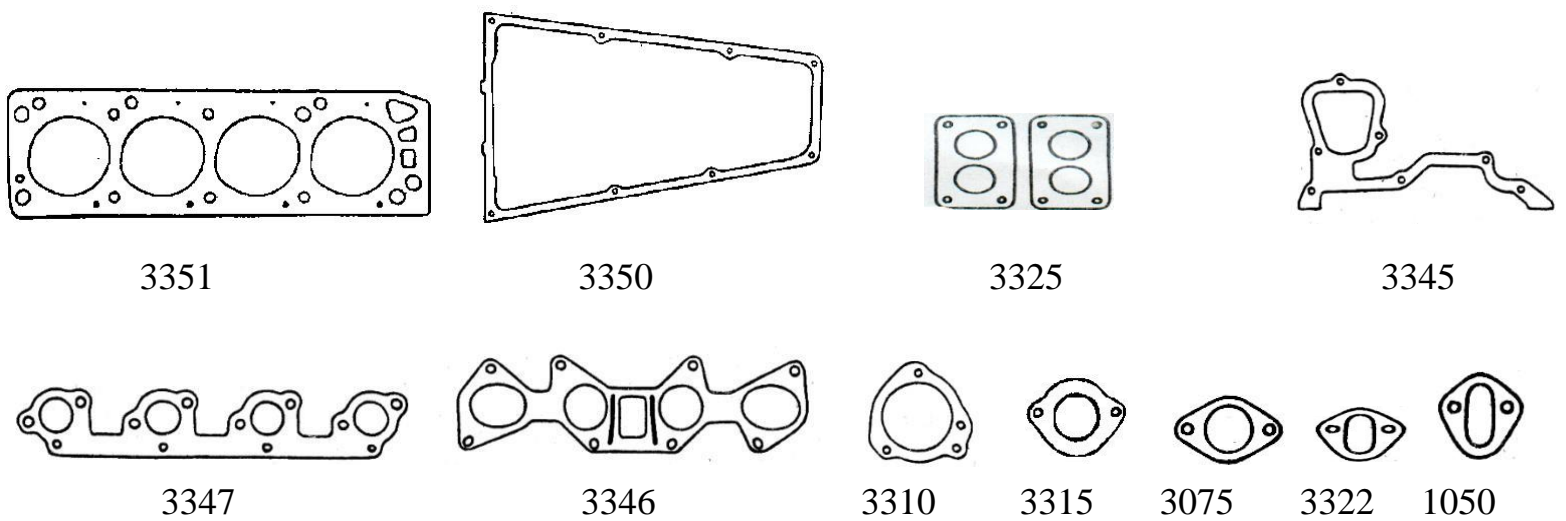

# FORD – VW 1,6 – ESCORT – SAVEIRO – SENDA – GOL

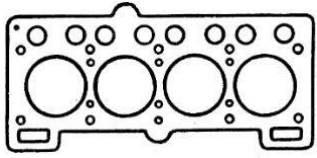

4451

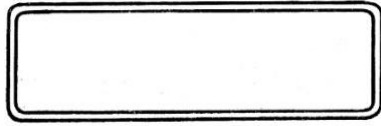

4450

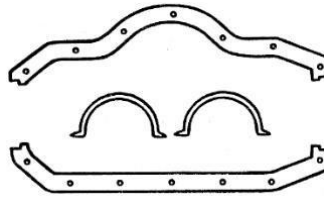

4444

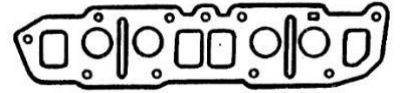

4448

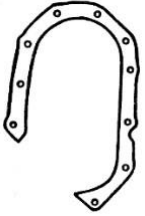

7080

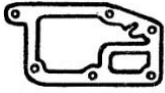

7045



4414



7050

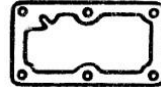

4418



4449



4415



4447



4416



# FORD V8 F1

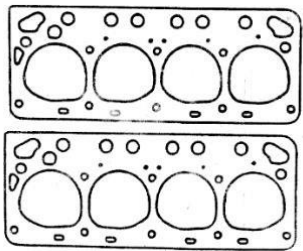

3255

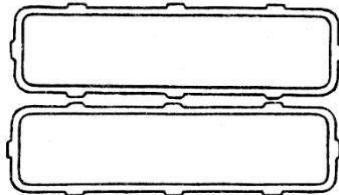

3250

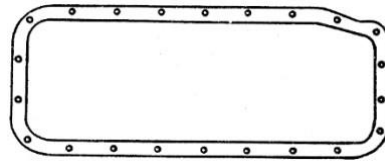

3210

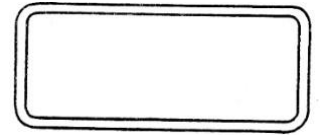

3248

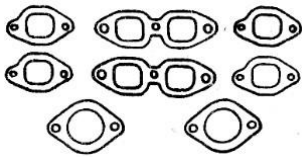

3245

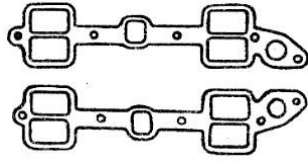

3244



3252

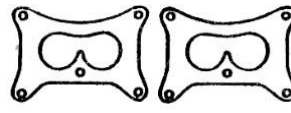

067

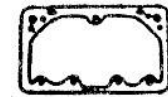

065

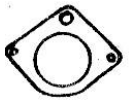

3202



066



064



1050

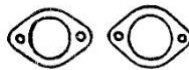

3253



3207



5006

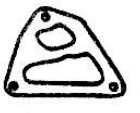

3201

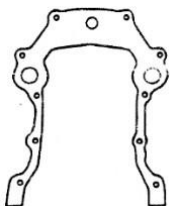

3249

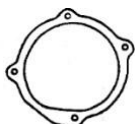

3200

# FORD V8 F2

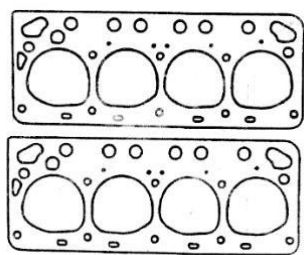

3256

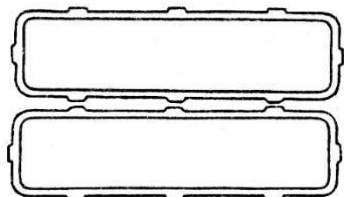

3250

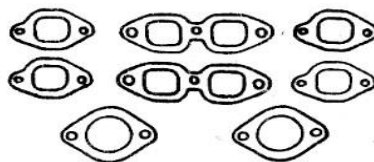

3210

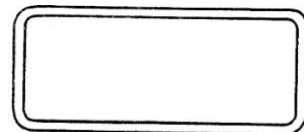

3248

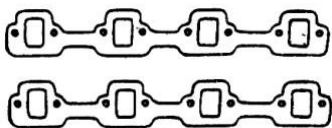

3247

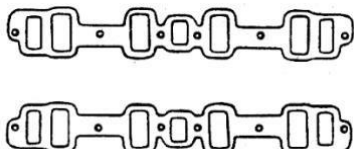

3246

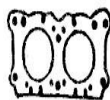

3202

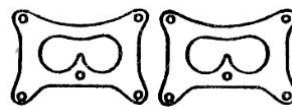

067

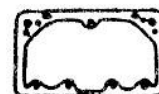

065

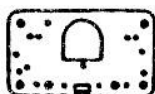

066



064



1050

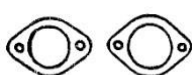

3253



3207



5006



3201

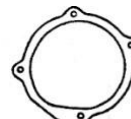

3200

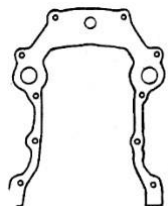

3249

## VW - FORD - CARAT - GALAXY - MOTOR AUDI 827 2000 CC

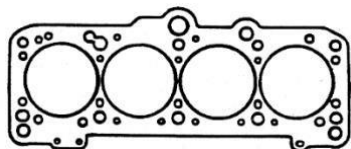

1887

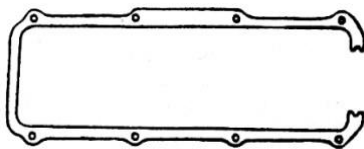

1880

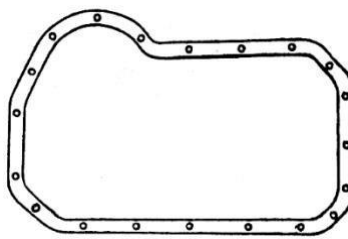

1870



1855

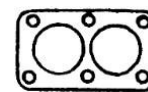

1877



1865



092

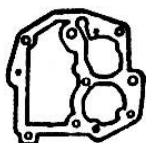

1878



1815



1863

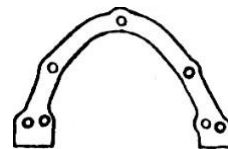

1875



1860



1864



1881



1861



1879



1853

# VW SENDA - DIESEL

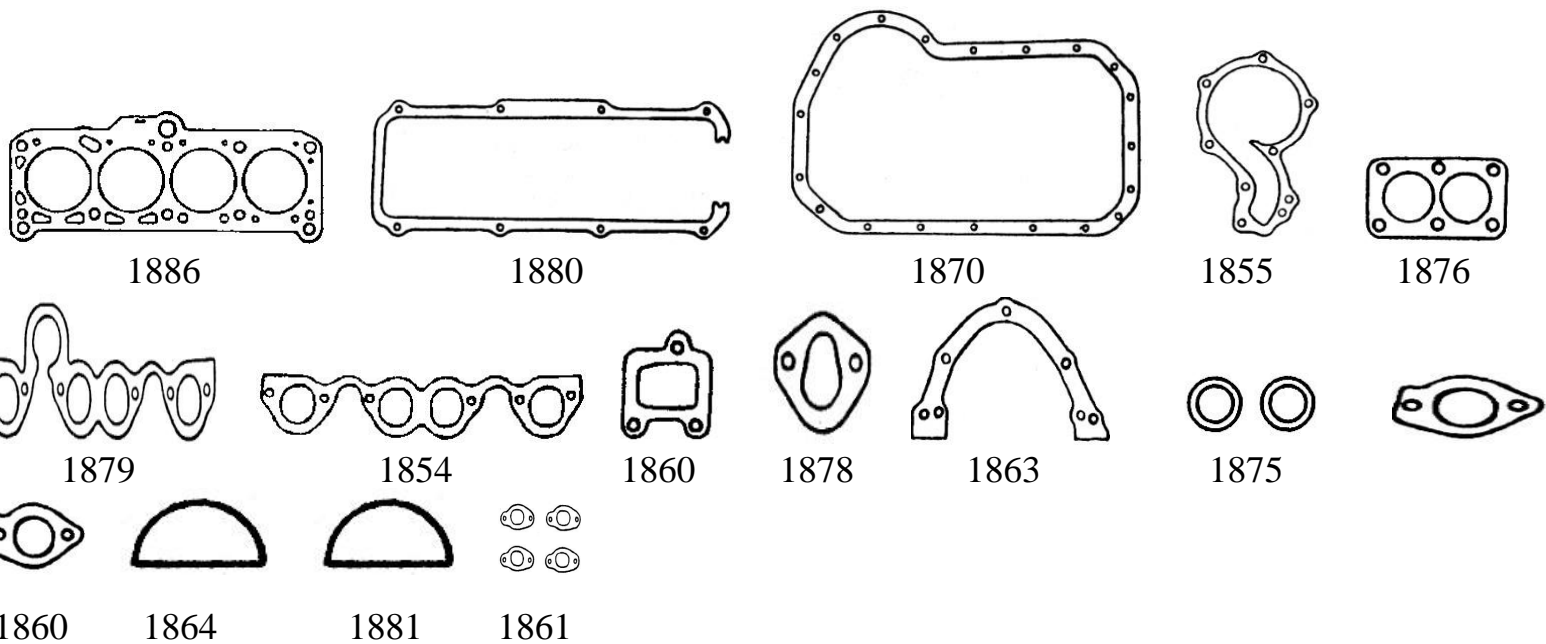

# FORD — FIESTA 1988/95 — COURIER 1991/... FIESTA — KA CARTER DE ACERO

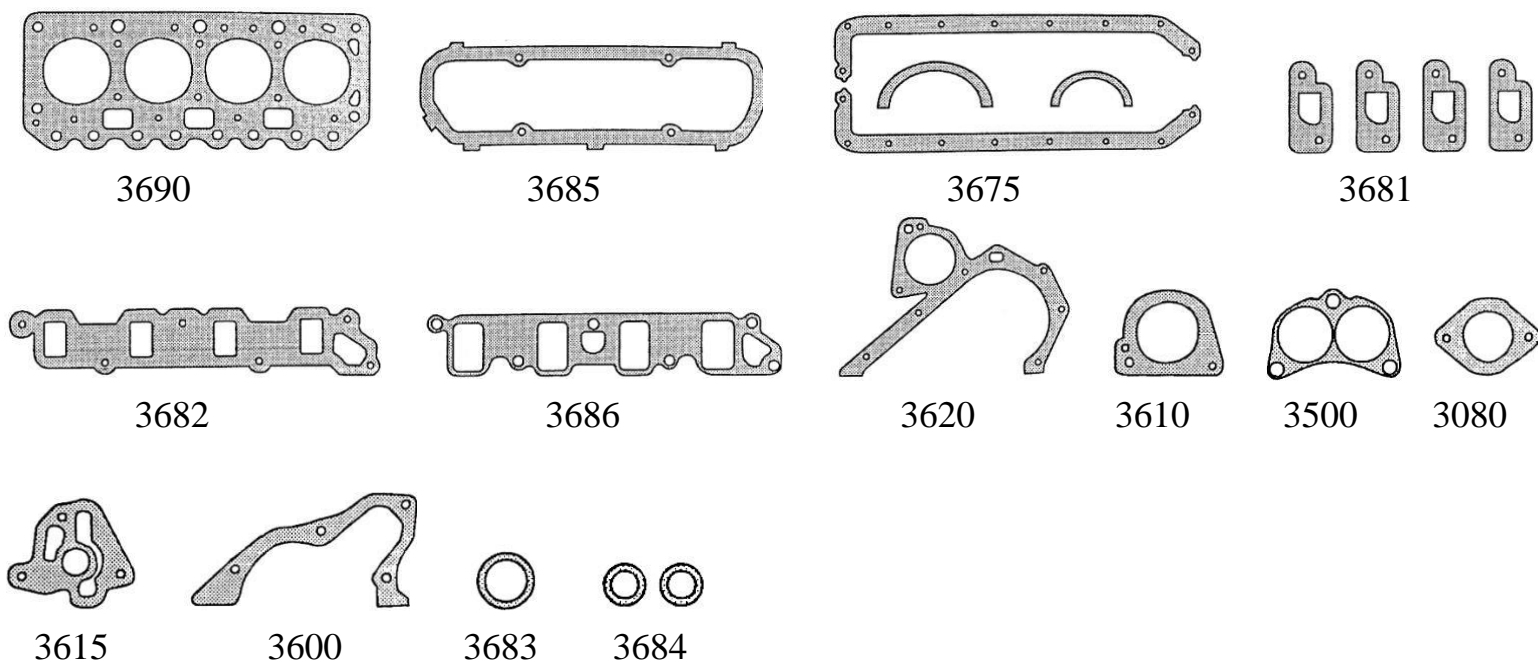

**FORD** – FIESTA – COURIER – ESCORD – MONDEO – ORION D  
 SIERRA TD – MONDEO TD 1991/... 1,8 CC ESCORD TDI 1994/...

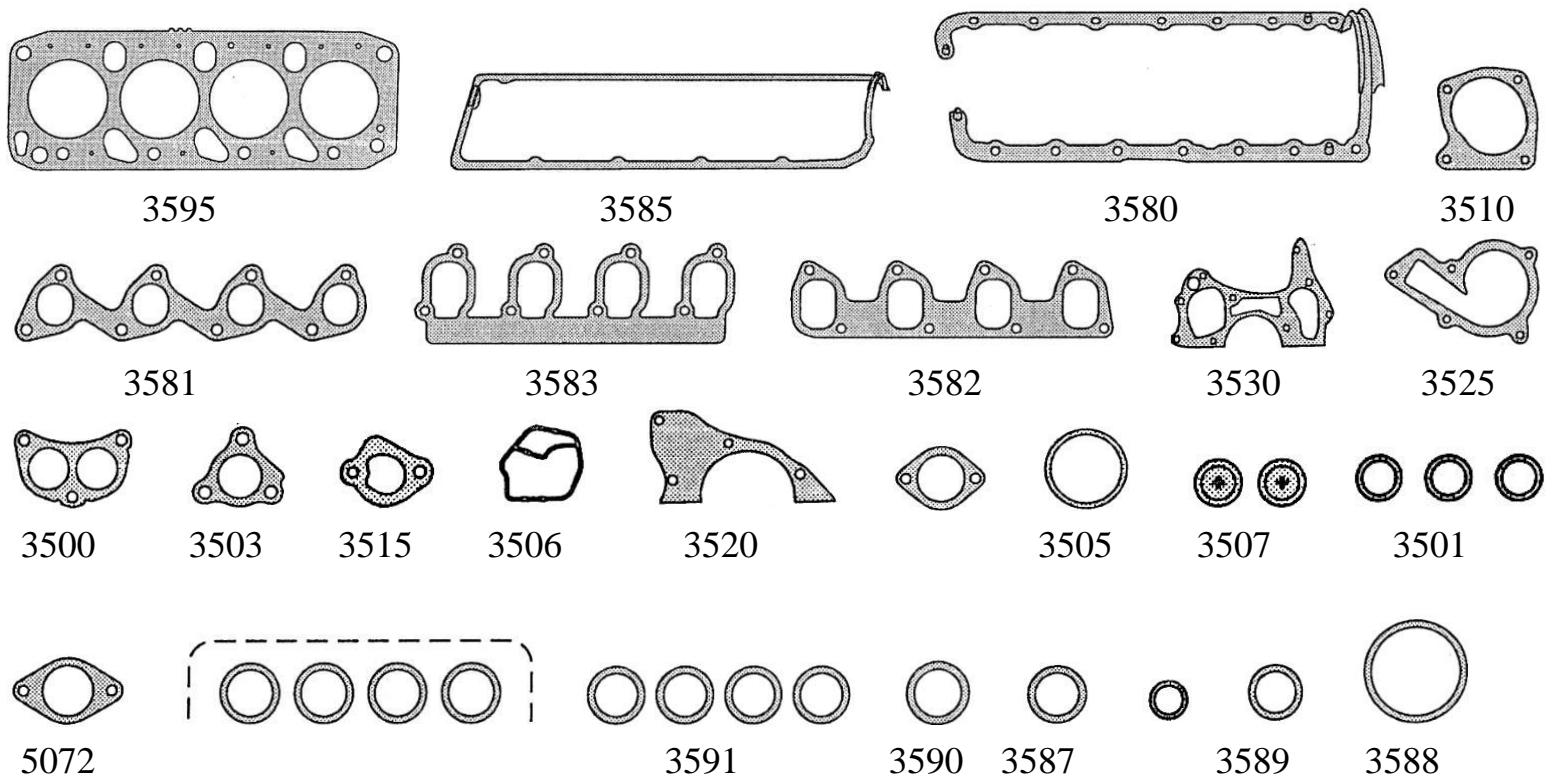

**FORD** MWM D229 4cil. 3922cc – F100 1993/95 –  
 1000 1994/96 – 4000 1992/93 – F2000 1980/...

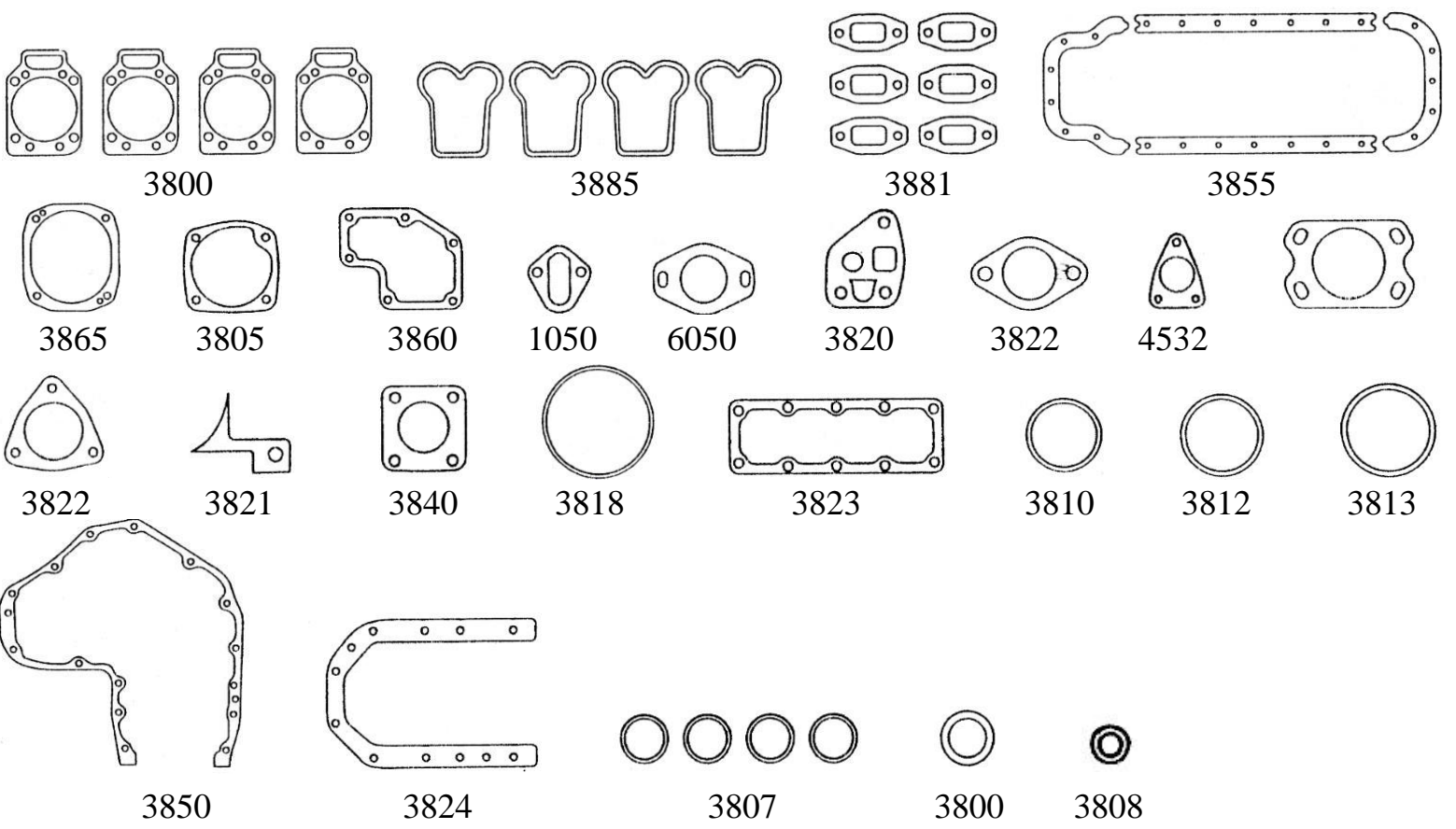

**FORD** MWM D229 6cil. 5883cc — F14000 DIESEL -  
F4000 1994/96

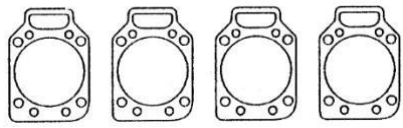

3800

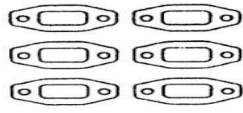

3885

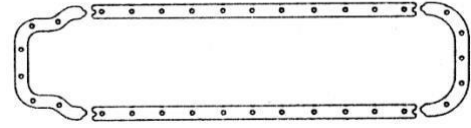

3890

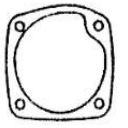

3865

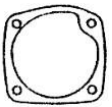

3805

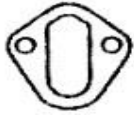

3860



1050

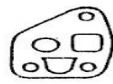

6050

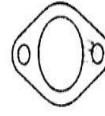

3820

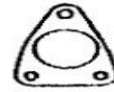

3822



4532

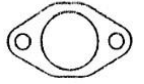

3825

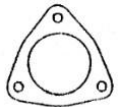

3822



3840

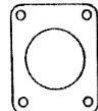

3835



3818

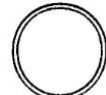

3813

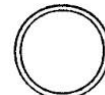

3812



3807



3810



3808



3810

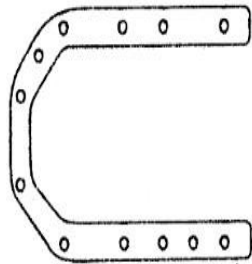

3850

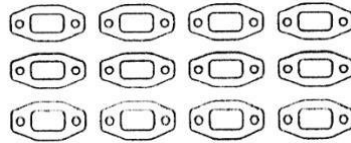

3881

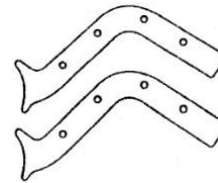

3870

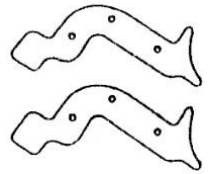

3821



# FORD MWM X10 6cil. 6450cc. 441HP 103

TURBO – FORD F14000 1995/98 – EURO 1/2 – VW 13180/15180/16210

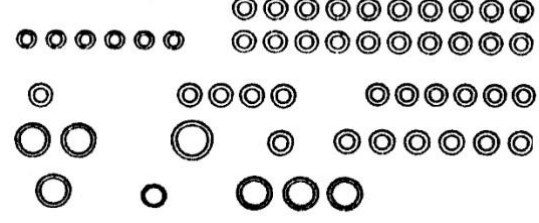
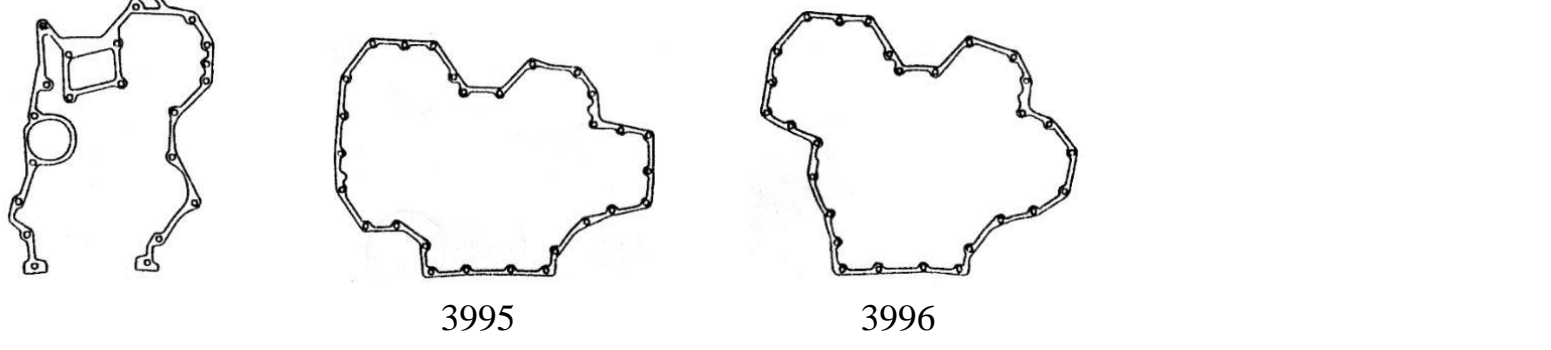
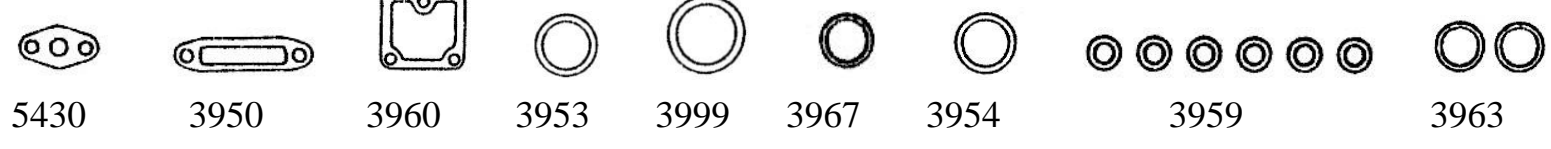
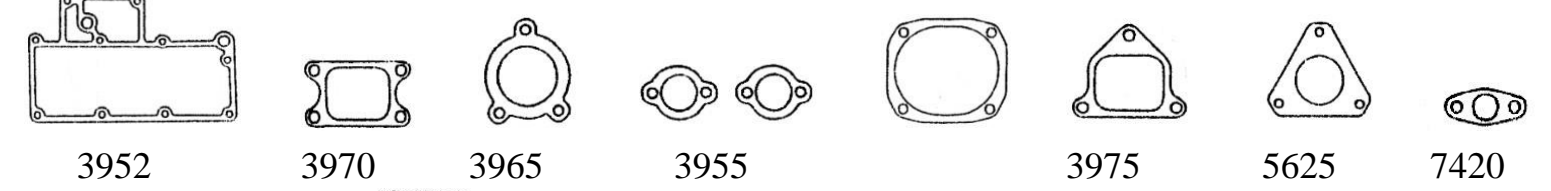
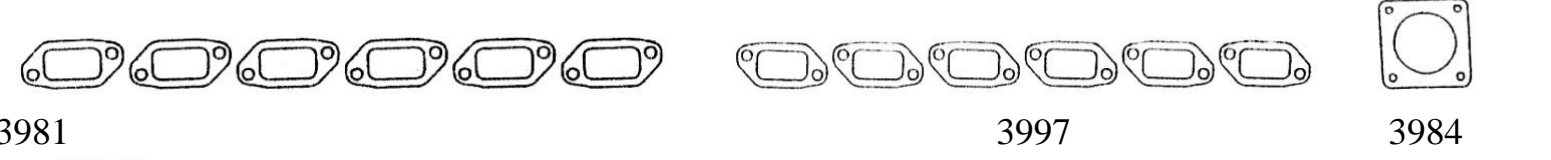
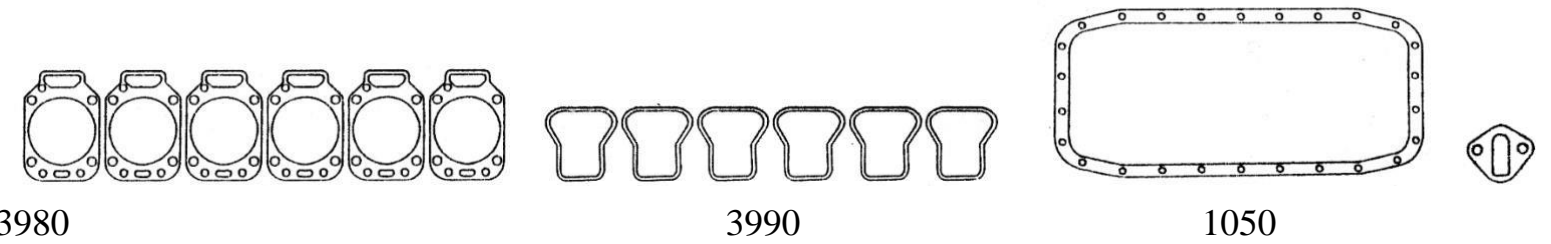

JUEGO DE ARANDELAS 3969

**FORD ZETEC 16V 1796cc.** – ESCORT – MONDEO –  
ORION – FIESTA – FIESTA XR2 – ESCORT RX 3I

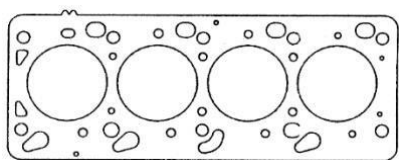

3750

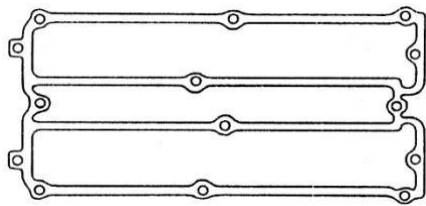

3785

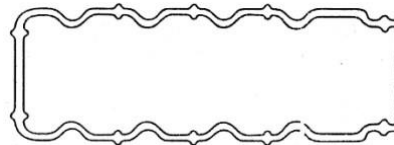

3735



3700



3781

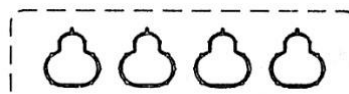
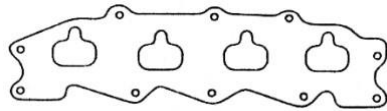

3730

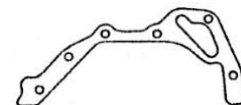

3720

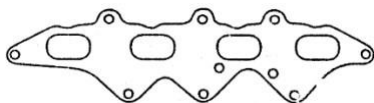

3725



3715



3705

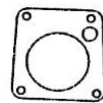

3710

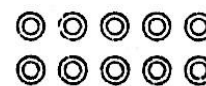

4155

**FORD** – TRANSIT – TRANSIT D/DL 1985/99

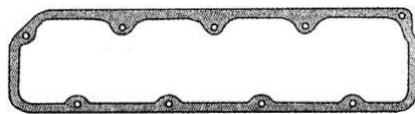
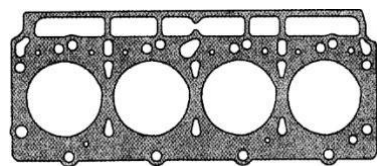

4185

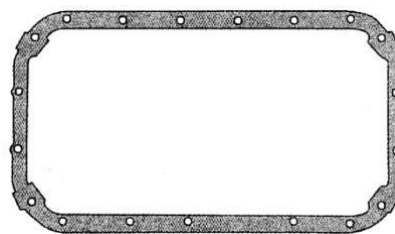

4135



4105

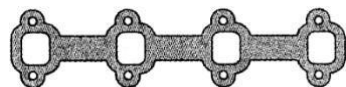

4181

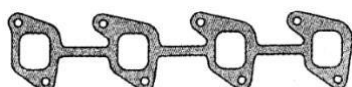

4170

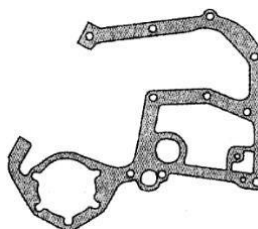

4160

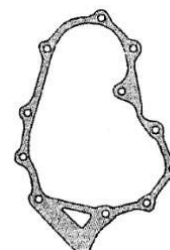

4165



4182

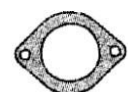

4120



4115



4100



4110



4155



3500

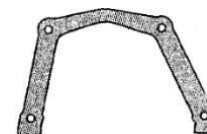

4175

**FORD** - KA 1999/... MOTOR ZETEC ROCAM ZL 999CC.

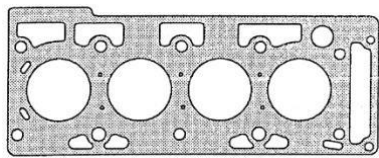

4210

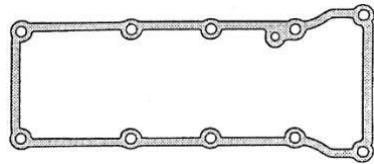

4200

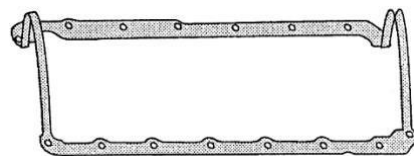

4235

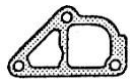

4211

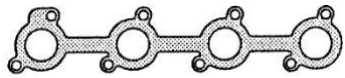

4201

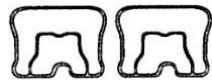

4205



4202

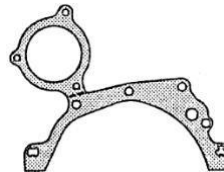

4210



4207



4206



4203



4208

**FORD** – MOTOR ZETEC ROCAM ZL 1598cc. – KA  
1997/... - FIESTA 1999/... - ESCORT - ECO SPORT 2003/...

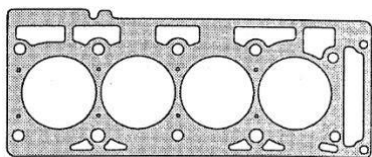

4215



4200



4235

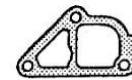

4211

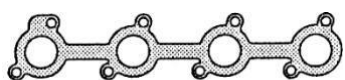

4201



4204



4202

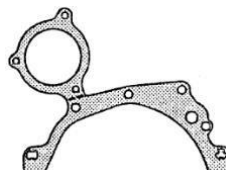

4210



4207



4206



4203



4208

**FORD** – MONDEO – ECO SPORT – FOCUS – RANGER 2.0 – 2.3

DURATEC 16V CJBA LF – L3 MAZDA – 6 – MPV

Jgo Motor S/T.CIL N° 3600/2 - Jgo Medio Motor S/T.CIL N° 3600/20

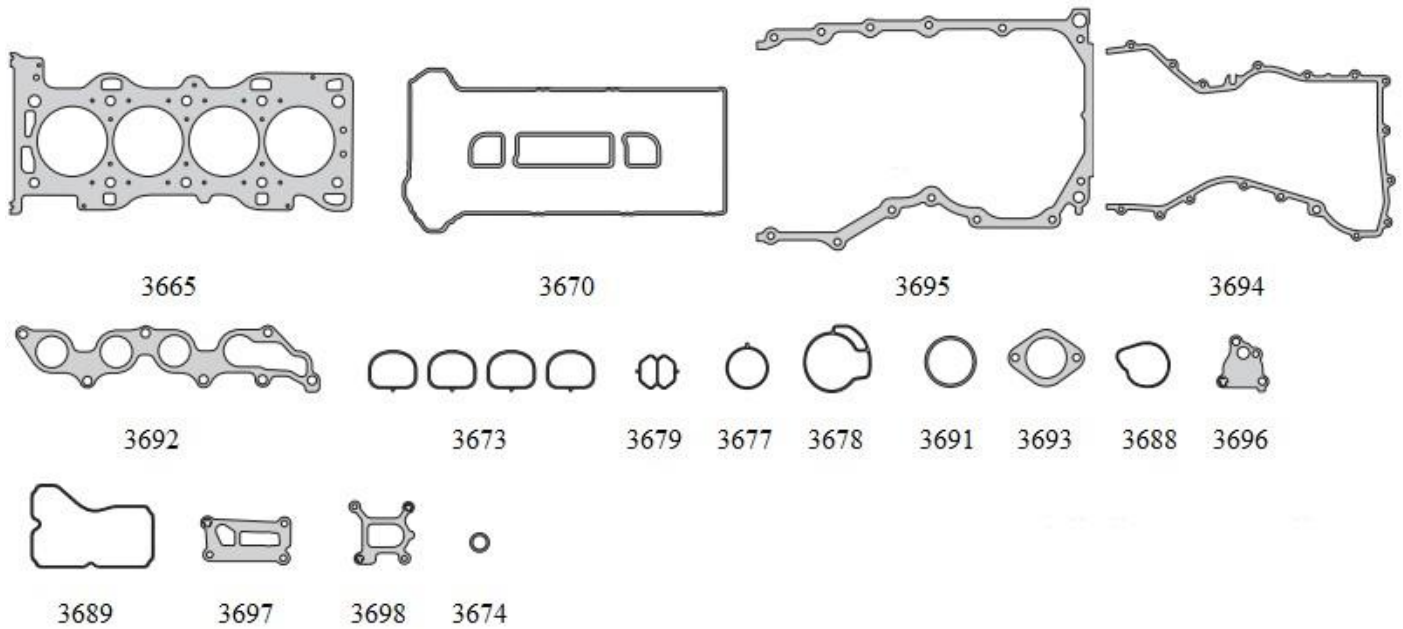

**FORD** – MONDEO 2.0 – RANGER 2.3

3600/3 Jgo Motor S/T.CIL 3600/30 Jgo Medio Motor S/T.CIL

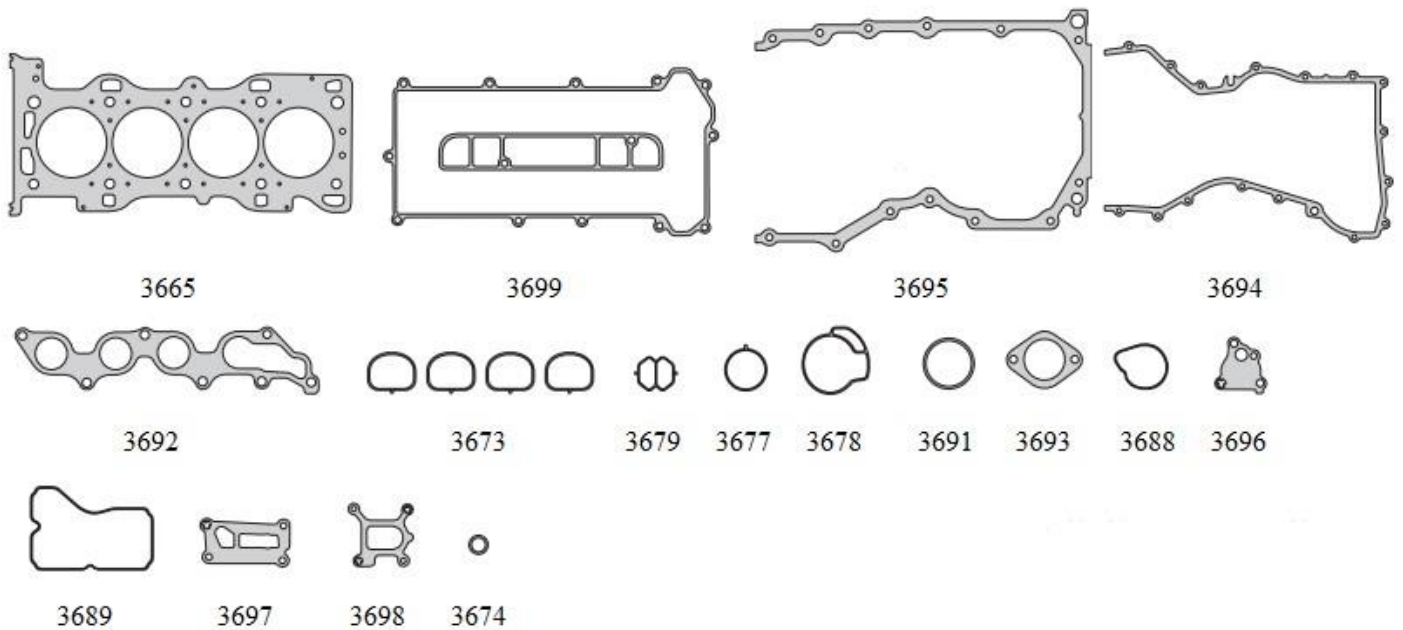

**FORD** – MOTOR MAXION TD 3.0 – RANGER 3.0 POWERSTROKE –

JGO MOTOR N° 4300/1 – MEDIO MOTOR N° 4300/10

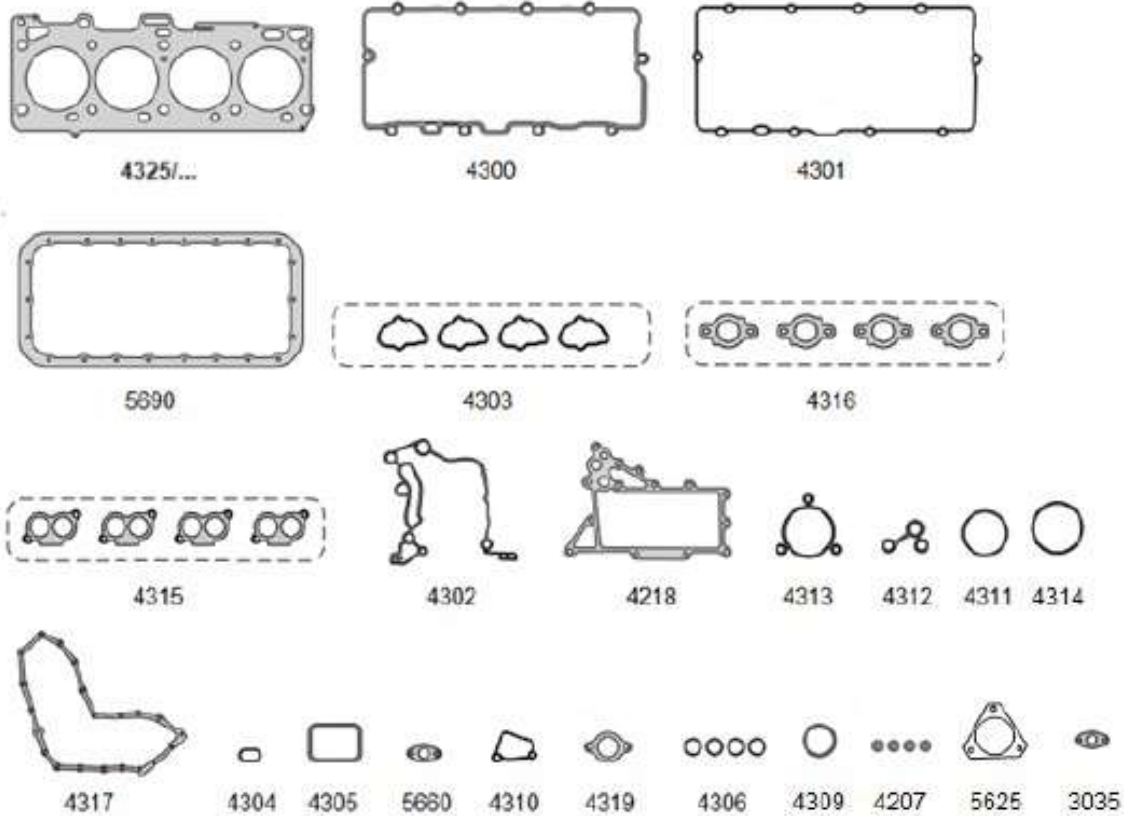

**FORD** – MOTOR SIGMA L4 1.5-1.6 – KA – FIESTA-FOCUS –

JGO MOTOR N° 3600/6 – MEDIO MOTOR N° 3600/61

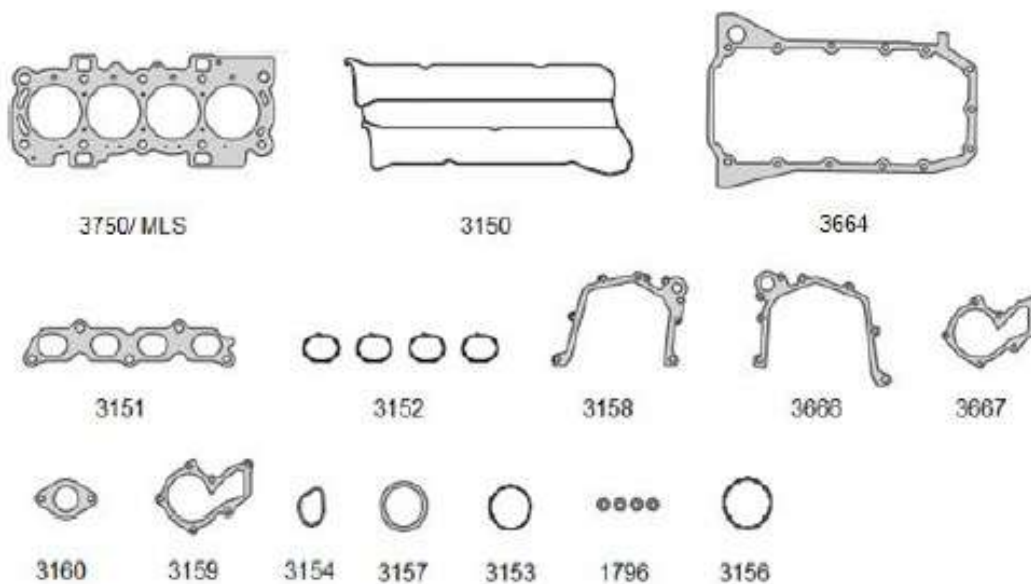

# FORD – MOTOR SIGMA FXJA 1.4 – FIESTA-

JGO MOTOR N° 3600/5 – MEDIO MOTOR N°3600/51

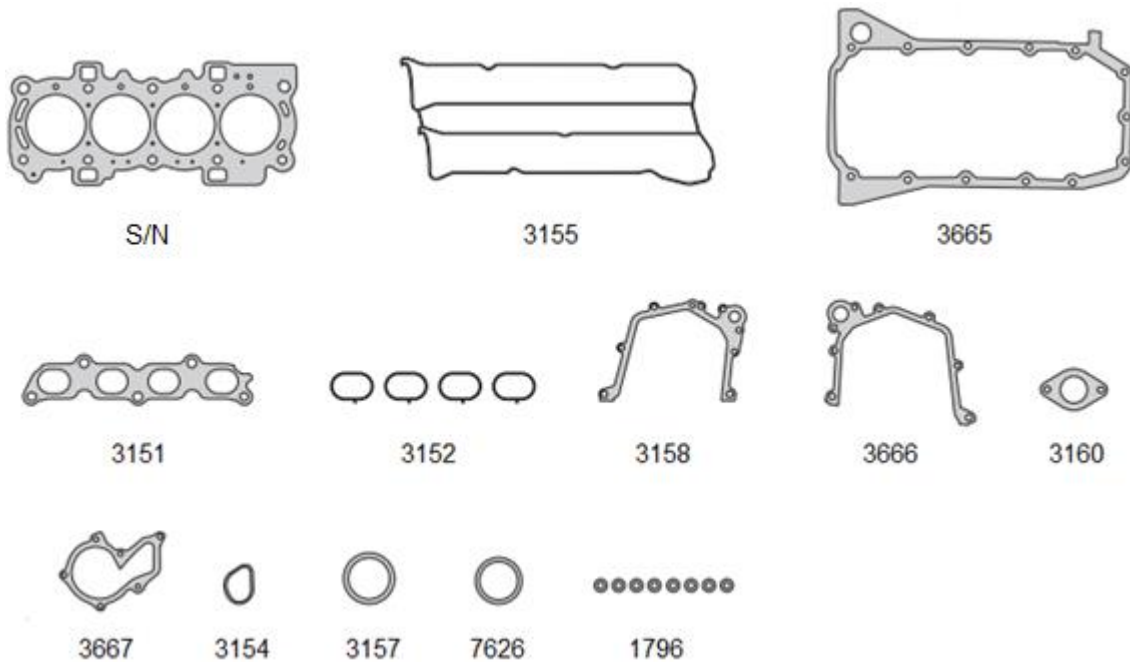

# FORD – MOTOR PUMA ZETEC SE 16V 1.4 – FIESTA –

JGO MOTOR N° 3600/4 – MEDIO MOTOR N° 3600/41

