

VOLKSWAGEN – GOLF – PASSAT 1992/96 . MOTOR ATU –

AWF – AWG – ADC

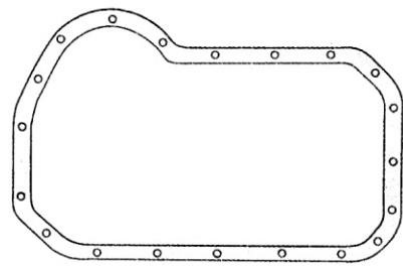
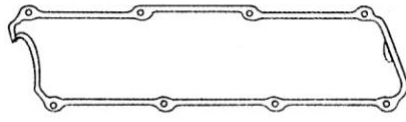
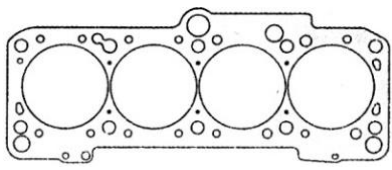

1898

1870

1855

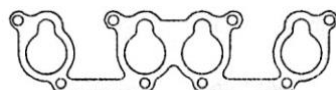
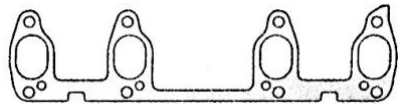

1879

1781/1

1783

3400

VOLKSWAGEN – POLO – GOL – GOLF – CADDY . MOTOR

DIESEL 1.9 CC

SEAT – IBIZA – TOLEDO – INCA . MOTOR DIESEL 1.9 CC

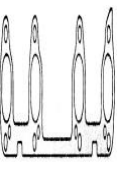
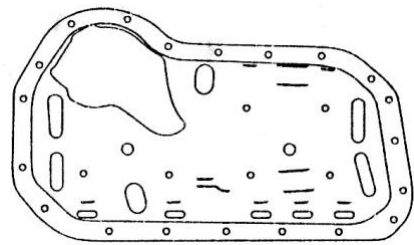
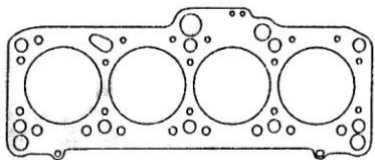

1977

1899

1970

1855

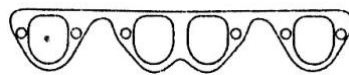
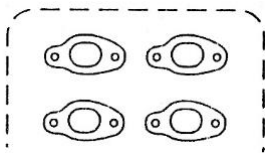
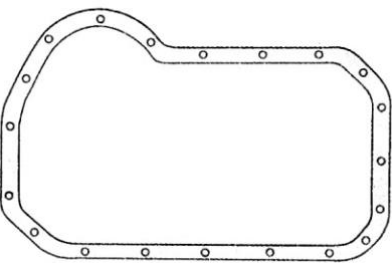

1870

1879

1978

1878

1857

1815

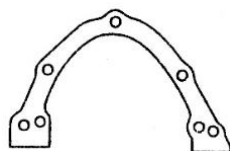
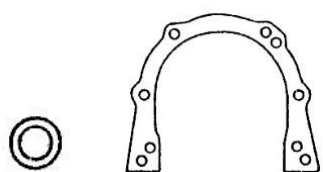

1976

1863

1875

1975

1971

1972

1974

VOLSWAGEN — GOL 1000 — SAVEIRO . MOTOR A.T 8V

SOHC

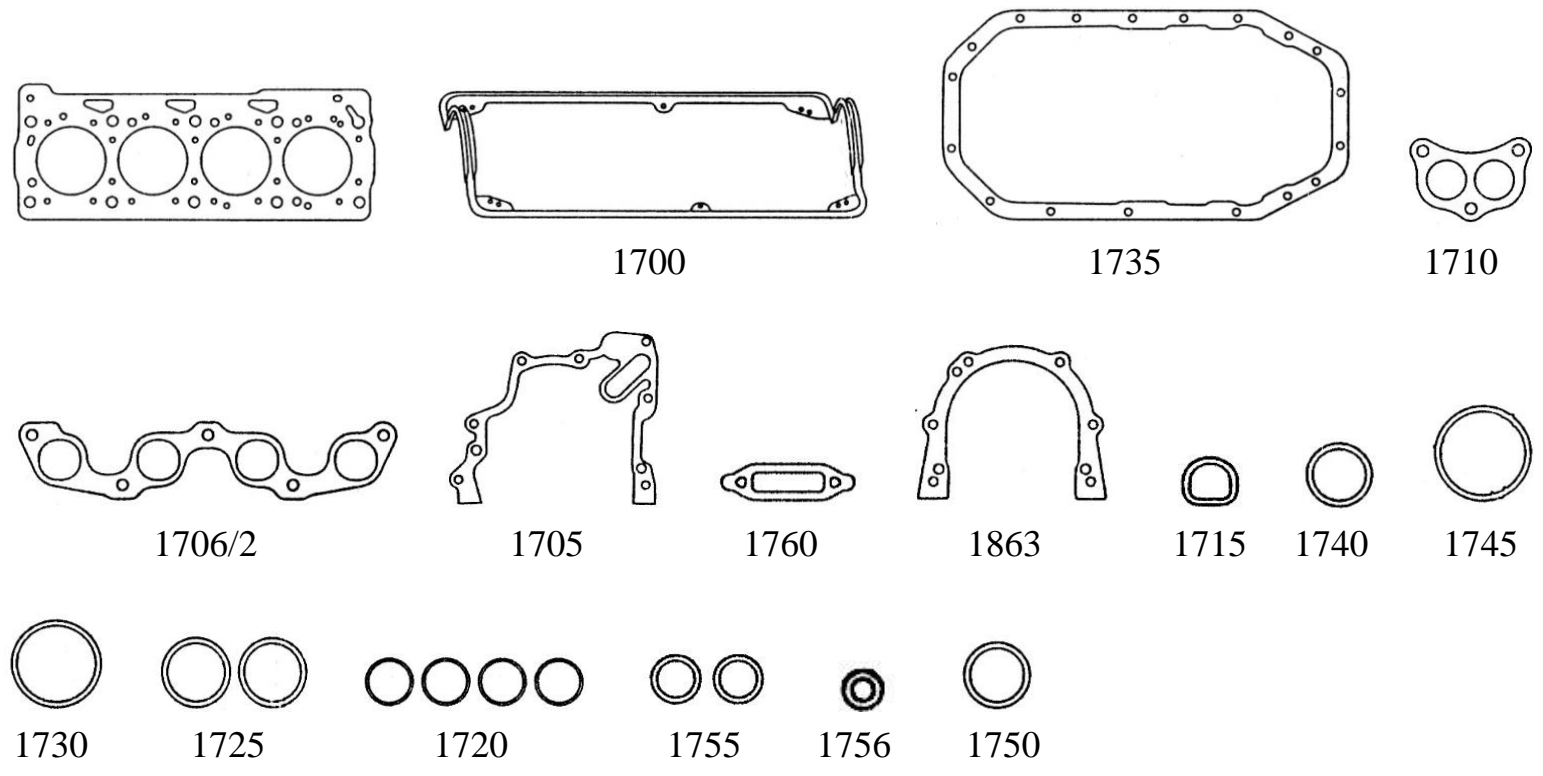

VOLSWAGEN — GOL — GOLF — POLO — PASSAT — SEAT —

IBIZA — TOLEDO .NAFTA 1,6 — 1,8 CC

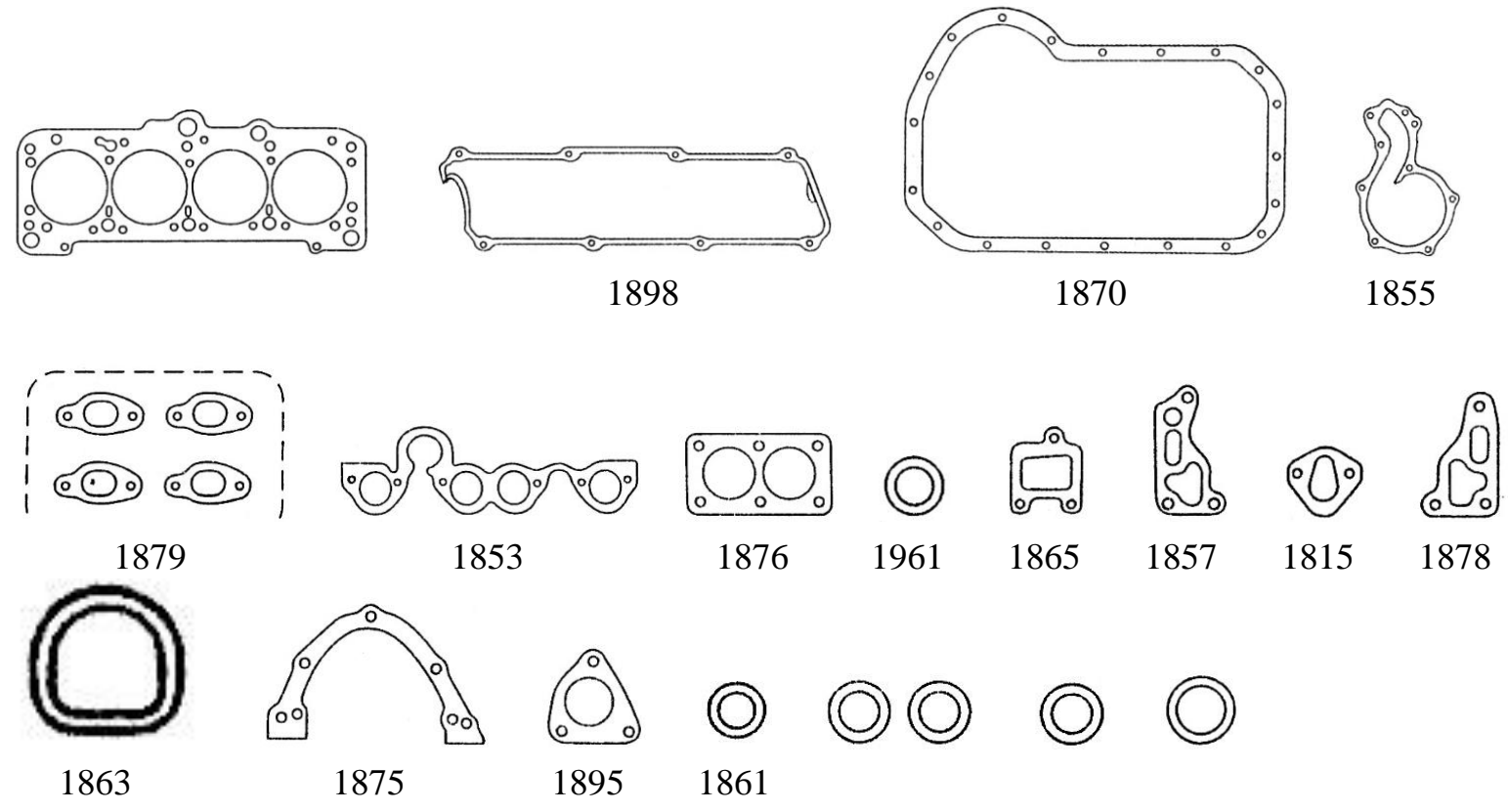

VOLSWAGEN – GACEL 1,6 cc.

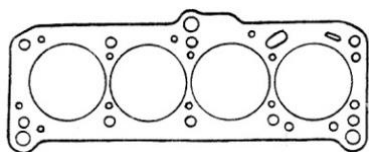

1882

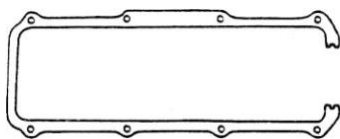

1880

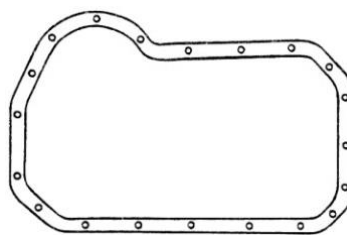

1870



1855

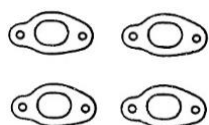

1879



1854

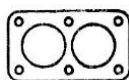

1876



1865

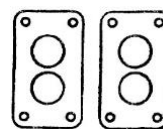

13



1878

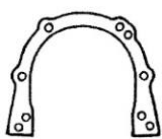

1863

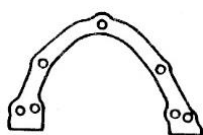

1875



1860



1864



1881

VOLSWAGEN – FORD 1,8CC. – ESCORT – SAVEIRO – SENDA – CARAT – GOL – GACEL

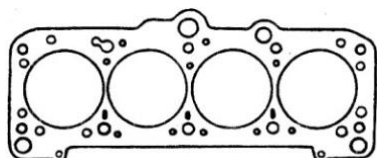

1884

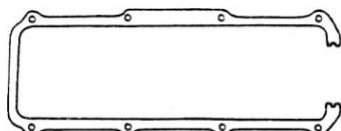

1880

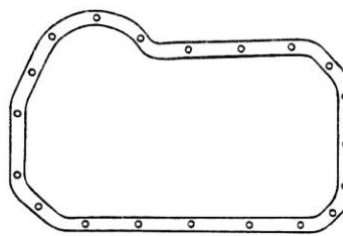

1870



1855

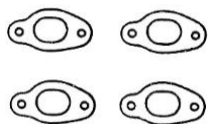

1879



1853



1876



1865

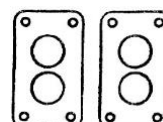

13



1878



1815

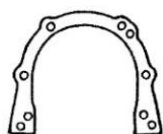

1863

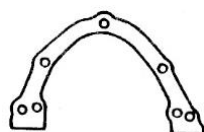

1875



1860



1864



1881

VOLKSWAGEN . TDI 1,9cc – POLO CLASSIC - GOLF

TDI/SDI – PASSAT TDI – VENTO TDI – CADDY SDI 1995/... - AUDI – A4 – A6 D/ TDI 1995/... - FORD – GALAXY TDI 1995/... - SEAT – IBIZA SDI/ TDI - CORDOBA 1995/...

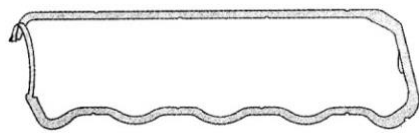
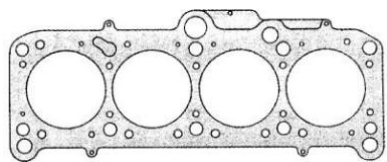

1980

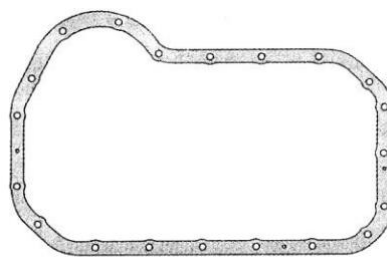

1870

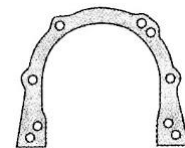

1863

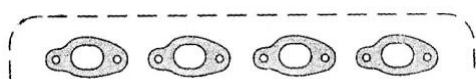

1879



1976



1878



1857



1815



1979



1971



1976



1875

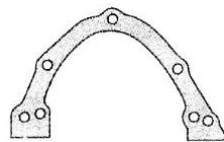

1972

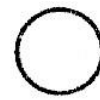

1861



1975



1973



1974

VOLKSWAGEN – MOTOR AXC/ATJ/BKE 1896 cm3

PASSAT TDI – SHARAN TDI 1999/...

TRANSPORTER TDI 2003/...

AUDI – A4 TDI 2000/2004/... – A6 TDI 2001/...

FORD – GALAXY TDI 2000/...

SEAT – ALHAMBRA TDI 2000/...

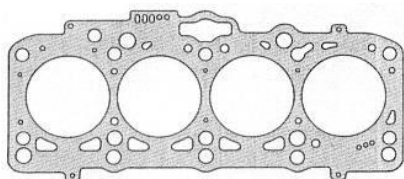

1998

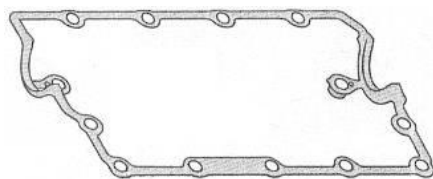

1996

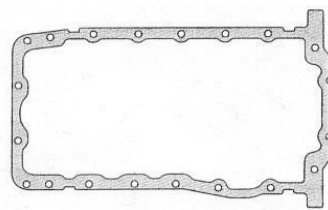

1990

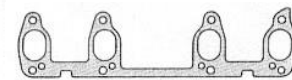

1879/2

1978

1981

1852

1979

2790

1994

1993

1750

VOLKSWAGEN – MOTOR ALH/AGR/AGP 1896 cm³

BORA – GOLF SDI/TDI 1997/...

AUDI – A3 TDI 1996/99

SKODA – OCTAVIA TDI 1996/...

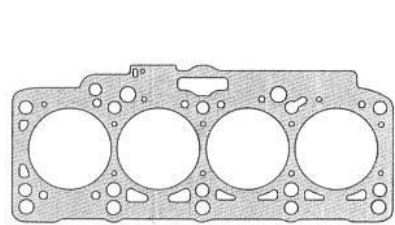

1997

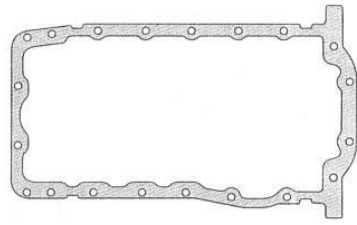

1990

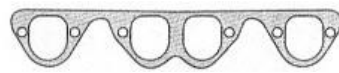

1978

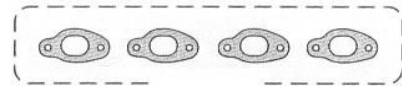

1879

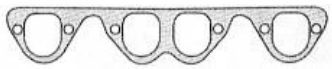

1981



1852



1983



1984



2790

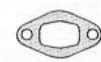

1988



1993



1992



1987



1994



1993

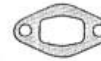

1992



1987



1994



1993



1992



1987

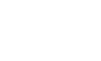

1994

VOLKSWAGEN – MOTOR AUD/BAH/(SOHC) 8V

1391/1595 cm³ - POLO – CADDY 1997/01 – GOL 2001/...

FOX 2005/... - FOX ROUTE – SURAN 2006/...

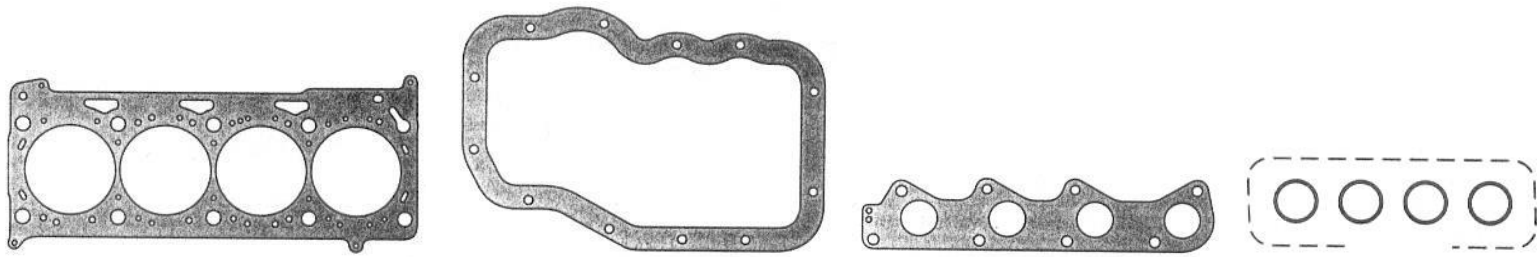

1785

1795

1790

1720

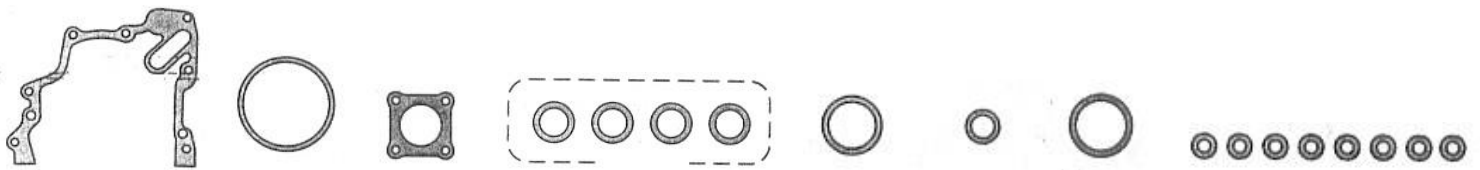

1705

1745

1856

1792

1793

1794

1796



1798

1725

1730

1797



1791

1760

1799

VOLKSWAGEN – MOTOR AJP/AGU/AJQ 1781 cm³

SHARAN – GOLF 20V TURBO 1997/...

GOLF 20V TURBO 1999/...

AUDI – A6 – A3 20V – A3 TURBO 20V 1996/...

SEAT – ALHAMBRA – LEON 20V TURBO 1998/...

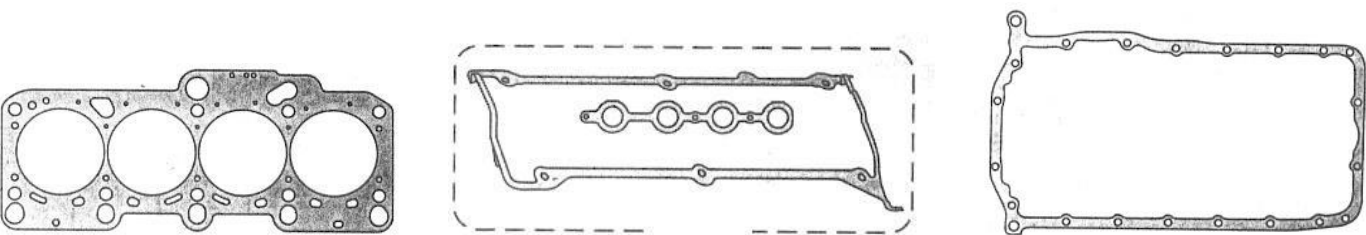

1920

1924

1990



1922

1921

1919

1923

1857

1918



3400

1914

1916

1917

1916

VOLKSWAGEN – MOTOR 1.8-2.0 - Passat TSI - Golf FSI - Tiguan

FSI Eos FSI - Passat FSI 2007/... Scirocco FSI 2008/...

AUDI - A3/Q5 TFSI 2008/... - A4/A5 2010/... CDAA/CDAB CDNB/CDNC

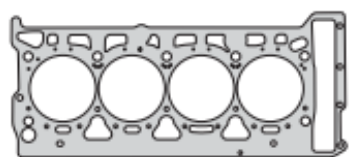

1965



1955



1951



1966



1903



1967



1948



1986



1946



1964



1968



1959



1947



1969



1902

VOLKSWAGEN – MOTOR 2.0 TSI - GOLF BORA VENTO 2.0 TFSI. B6

BPY-BWA

AUDI - A3-A4-A6



1940

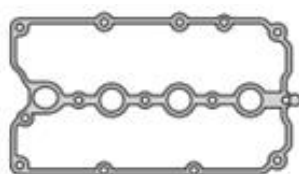

1952



1951



1968



1948



1959



1957

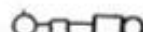

1956



1954



1796



1993



1989



1774



1460



1955



6382

VOLKSWAGEN – MOTOR DOHC 16V 1.6 – SURAN –
SURAN CROSS – SAVEIRO – NUEVO FOX – GOL – SAVEIRO CROSS 2015/...

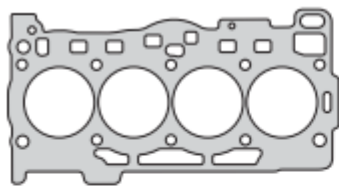

1762

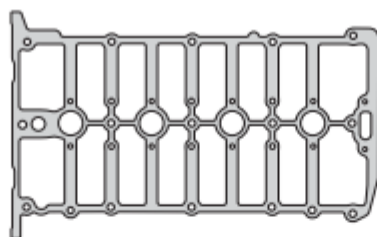

1763

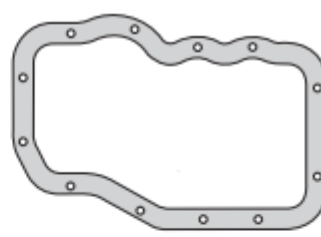

1795



1708

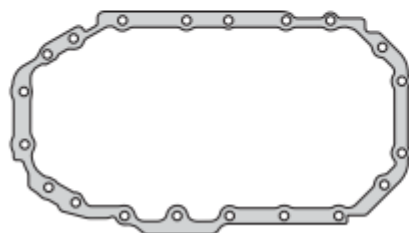

1764



1722



1717



1712



1721